

Discrete Mathematics in Computer Science

Subgraphs

Malte Helmert, Gabriele Röger

University of Basel

Overview

- We conclude our discussion of (di-) graphs by giving a brief tour of some further topics in graph theory that we do not have time to discuss in depth.
- In the interest of brevity (and hence wider coverage of topics), we do not give proofs for the results in this chapter.

Subgraphs

Definition (subgraph)

A **subgraph** of a graph (V, E) is a graph (V', E') with $V' \subseteq V$ and $E' \subseteq E$.

A **subgraph** of a digraph (N, A) is a digraph (N', A') with $N' \subseteq N$ and $A' \subseteq A$.

German: Teilgraph/Untergraph

Subgraphs

Definition (subgraph)

A **subgraph** of a graph (V, E) is a graph (V', E') with $V' \subseteq V$ and $E' \subseteq E$.

A **subgraph** of a digraph (N, A) is a digraph (N', A') with $N' \subseteq N$ and $A' \subseteq A$.

German: Teilgraph/Untergraph

Question: Can we choose V' and E' arbitrarily?

Subgraphs

Definition (subgraph)

A **subgraph** of a graph (V, E) is a graph (V', E') with $V' \subseteq V$ and $E' \subseteq E$.

A **subgraph** of a digraph (N, A) is a digraph (N', A') with $N' \subseteq N$ and $A' \subseteq A$.

German: Teilgraph/Untergraph

Question: Can we choose V' and E' arbitrarily?

The subgraph relationship defines a **partial order** on graphs (and on digraphs).

Subgraphs – Example

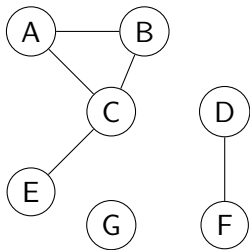

graph (V, E)

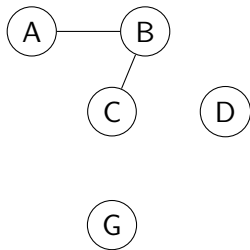

subgraph (V', E')

Induced Subgraphs (1)

Definition (induced subgraph)

Let $G = (V, E)$ be a graph, and let $V' \subseteq V$.

The **subgraph of G induced by V'** is the graph (V', E') with $E' = \{\{u, v\} \in E \mid u, v \in V'\}$.

We say that G' is **an induced subgraph** of $G = (V, E)$ if G' is the subgraph of G induced by V' for any set of vertices $V' \subseteq V$.

German: induzierter Teilgraph (eines Graphen)

Induced Subgraphs (2)

Definition (induced subgraph)

Let $G = (N, A)$ be a digraph, and let $N' \subseteq N$.

The **subgraph of G induced by N'** is the digraph (N', A') with $A' = \{(u, v) \in A \mid u, v \in N'\}$.

We say that G' is **an induced subgraph** of $G = (N, A)$ if G' is the subgraph of G induced by N' for any set of nodes $N' \subseteq N$.

German: induzierter Teilgraph (eines gerichteten Graphen)

Induced Subgraphs – Example

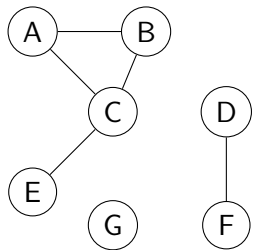

graph (V, E)

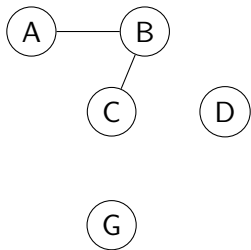

Is this an induced subgraph?

Induced Subgraphs – Example

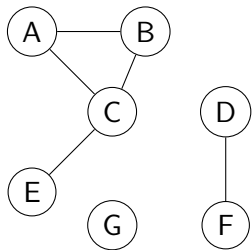

graph (V, E)

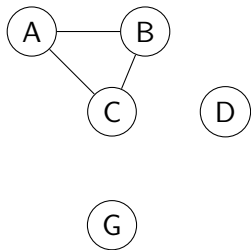

This is an induced subgraph.

Induced Subgraphs – Discussion

- Induced subgraphs are subgraphs.
- They are the **largest** (in terms of the set of edges) subgraphs with any given set of vertices.
- A typical example are subgraphs induced by the connected components of a graph.
- The subgraphs induced by the connected components of a forest are trees.

Counting Subgraphs

- How many subgraphs does a graph (V, E) have?
- How many induced subgraph does a graph (V, E) have?

Counting Subgraphs

- How many subgraphs does a graph (V, E) have?
- How many induced subgraph does a graph (V, E) have?

For the second question, the answer is $2^{|V|}$.

The first question is in general not easy to answer because vertices and edges of a subgraph cannot be chosen independently.

Counting Subgraphs

- How many subgraphs does a graph (V, E) have?
- How many induced subgraph does a graph (V, E) have?

For the second question, the answer is $2^{|V|}$.

The first question is in general not easy to answer because vertices and edges of a subgraph cannot be chosen independently.

Example (subgraphs of a complete graph)

A **complete** graph with n vertices (i.e., with all possible $\binom{n}{2}$ edges) has $\sum_{k=0}^n \binom{n}{k} 2^{\binom{k}{2}}$ subgraphs. (Why?)

for $n = 10$: 1024 induced subgraphs, 35883905263781 subgraphs

Discrete Mathematics in Computer Science

Isomorphism

Malte Helmert, Gabriele Röger

University of Basel

Motivation

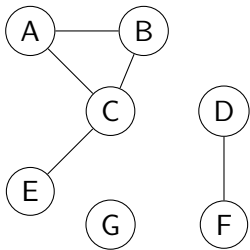

graph (V, E)

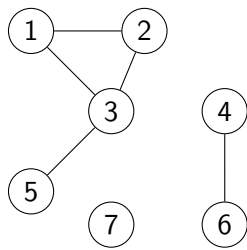

graph (V', E')

What is the difference between these graphs?

Isomorphism

- In many cases, the “names” of the vertices of a graph do not have any particular semantic meaning.
- Often, we care about the **structure** of the graph, i.e., the relationship between the vertices and edges, but not what we **call** the different vertices.
- This is captured by the concept of **isomorphism**.

Isomorphism – Definition

Definition (Isomorphism)

Let $G = (V, E)$ and $G' = (V', E')$ be graphs.

An **isomorphism** from G to G' is a **bijective** function

$\sigma : V \rightarrow V'$ such that for all $u, v \in V$:

$$\{u, v\} \in E \quad \text{iff} \quad \{\sigma(u), \sigma(v)\} \in E'.$$

If there exists an isomorphism from G to G' ,
we say that they are **isomorphic**, in symbols $G \cong G'$.

German: Isomorphismus, isomorph

- derives from Ancient Greek for “equally shaped/formed”
- analogous definition for digraphs omitted

Isomorphism – Example

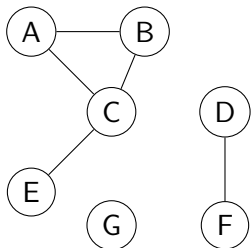

graph (V, E)

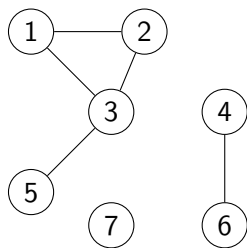

graph (V', E')

- $\sigma = \{A \mapsto 1, B \mapsto 2, C \mapsto 3, D \mapsto 4, E \mapsto 5, F \mapsto 6, G \mapsto 7\}$
- for example: $\{A, B\} \in E$ and $\{\sigma(A), \sigma(B)\} = \{1, 2\} \in E'$
- for example: $\{A, D\} \notin E$ and $\{\sigma(A), \sigma(D)\} = \{1, 4\} \notin E'$

Isomorphism – Discussion

- The **identity function** is an isomorphism.
- The **inverse** of an isomorphism is an isomorphism.
- The **composition** of two isomorphisms is an isomorphism (when defined over matching sets of vertices)

It follows that being isomorphic is an **equivalence relation**.

Isomorphic or Not? (1)

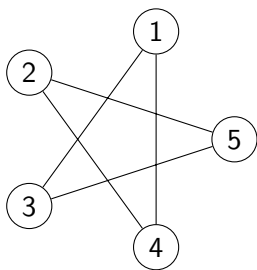
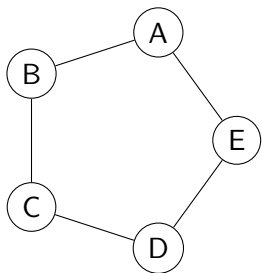

Isomorphic or Not? (1)

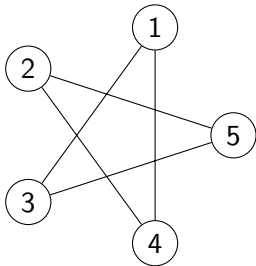
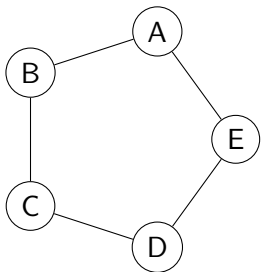

isomorphic

$$\sigma = \{A \mapsto 1, B \mapsto 3, C \mapsto 5, D \mapsto 2, E \mapsto 4\}$$

Isomorphic or Not? (2)

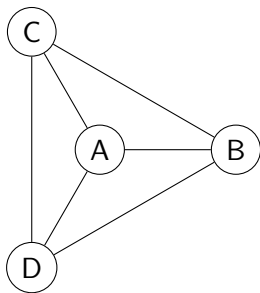
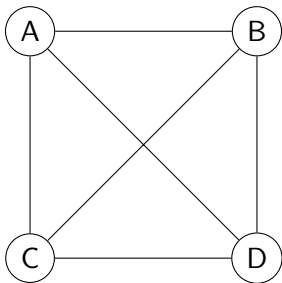

Isomorphic or Not? (2)

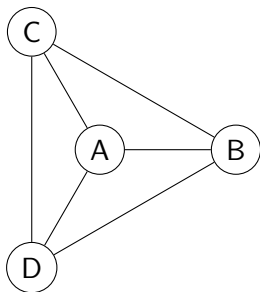
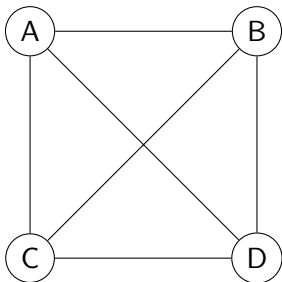

isomorphic

\rightsquigarrow in fact, the same graph!

$$\sigma = \{A \mapsto A, B \mapsto B, C \mapsto C, D \mapsto D\}$$

Isomorphic or Not? (3)

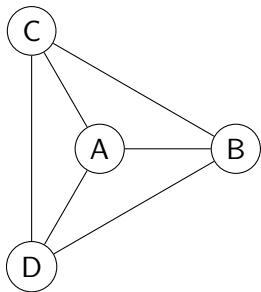
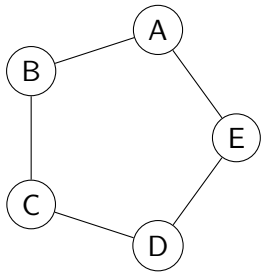

Isomorphic or Not? (3)

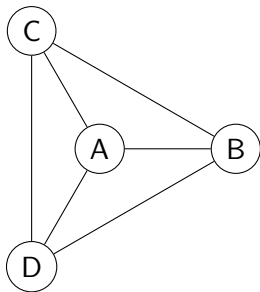
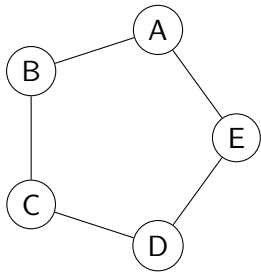

not isomorphic

There does not even exist a bijection between the vertices.

Isomorphic or Not? (4)

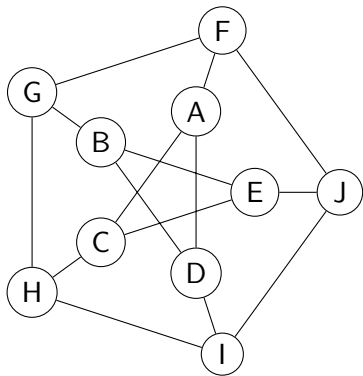
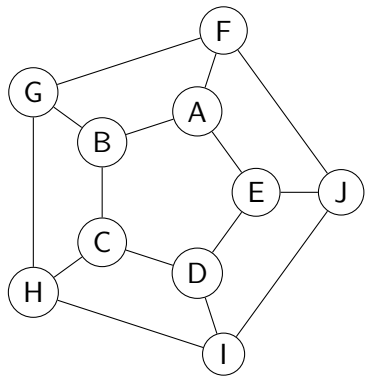

isomorphic or not?

Proving and Disproving Isomorphism

- To prove that two graphs **are** isomorphic, it suffices to state an isomorphism and verify that it has the required properties.

Proving and Disproving Isomorphism

- To prove that two graphs **are** isomorphic, it suffices to state an isomorphism and verify that it has the required properties.
- To prove that two graphs are **not** isomorphic, we must rule out all possible bijections.
 - With n vertices, there are $n!$ bijections.
 - **example** $n = 10$: $10! = 3628800$

Proving and Disproving Isomorphism

- To prove that two graphs **are** isomorphic, it suffices to state an isomorphism and verify that it has the required properties.
- To prove that two graphs are **not** isomorphic, we must rule out all possible bijections.
 - With n vertices, there are $n!$ bijections.
 - **example** $n = 10$: $10! = 3628800$
- A common disproof idea is to identify a **graph invariant**, i.e., a property of a graph that must be **the same** in isomorphic graphs, and show that it differs.
 - **examples**: number of vertices, number of edges, maximum/minimum degree, sorted sequence of all degrees, number of connected components

Isomorphic or Not? (5)

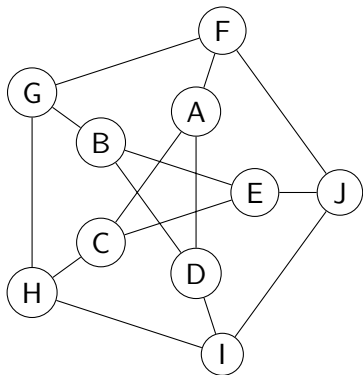
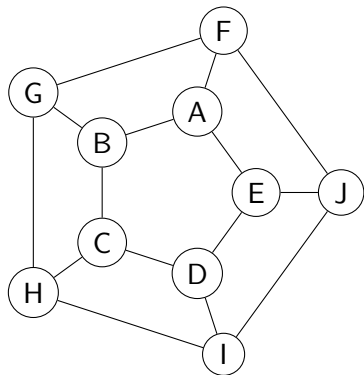

not isomorphic

- The left graph has cycles of length 4 (e.g., $\langle A, B, G, F, A \rangle$).
- The right graph does not.
- Having a cycle of a given length is an invariant.

Scientific Pop Culture

- Determining if two graphs are isomorphic is an algorithmic problem that has been famously resistant to studying its complexity.
- For more than 40 years, we have not known if polynomial algorithms exist, and we also do not know if it belongs to the famous class of **NP-complete** problems.
- In 2015, László Babai announced an algorithm with **quasi-polynomial** (worse than polynomial, better than exponential) runtime.

Further Reading

Martin Grohe, Pascal Schweitzer.

[The Graph Isomorphism Problem.](#)

Communications of the ACM 63(11):128–134, November 2020.

<https://dl.acm.org/doi/10.1145/3372123>

Symmetries, Automorphisms and Group Theory

- An isomorphism σ between a graph G and itself is called an **automorphism** or **symmetry** of G .
- For every graph, its symmetries are permutations of its vertex set that form a **group** (with function composition as the binary operation) called the **automorphism group** of the graph.

Example: the symmetric group S_n is the automorphism group of the complete graph with the vertices $\{1, \dots, n\}$.

Automorphism Group of a Graph

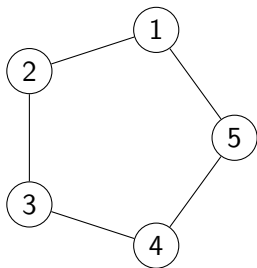

What are the symmetries?

Automorphism Group of a Graph

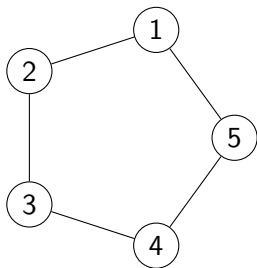

What are the symmetries?

- one example is the **rotation**
 $\sigma_1 = \{1 \mapsto 2, 2 \mapsto 3, 3 \mapsto 4, 4 \mapsto 5, 5 \mapsto 1\}$
- another example is the **reflection**
 $\sigma_2 = \{1 \mapsto 5, 2 \mapsto 4, 3 \mapsto 3, 4 \mapsto 2, 5 \mapsto 1\}$
- There are 10 symmetries in total,
and they are all **generated** by σ_1 and σ_2 .

Discrete Mathematics in Computer Science

Planarity and Minors

Malte Helmert, Gabriele Röger

University of Basel

Planarity

- We often draw graphs as 2-dimensional pictures.
- When we do so, we usually try to draw them in such a way that different edges do not cross.
- This often makes the picture neater and the edges easier to visualize.
- A picture of a graph with no edge crossings is called a **planar embedding**.
- A graph for which a planar embedding exists is called **planar**.

Planar Embeddings – Example

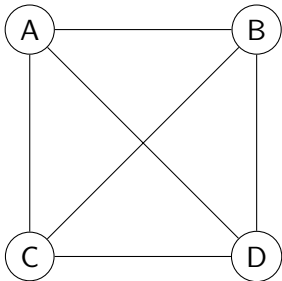

not a planar embedding

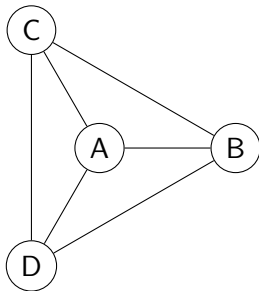

planar embedding

Planar Embeddings – Example

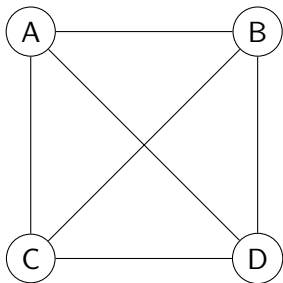

not a planar embedding

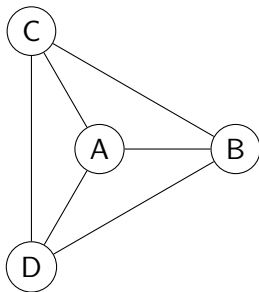

planar embedding

The complete graph over 4 vertices is planar.

Planar Graphs

Definition (planar)

A graph $G = (V, E)$ is called **planar** if there exists a **planar embedding** of G , i.e., a picture of G in the Euclidean plane in which no two edges intersect.

German: planar

Notes:

- We do not formally define planar embeddings, as this is nontrivial and not necessary for our discussion.
- In general, we may draw edges as arbitrary curves.
- However, it is possible to show that a graph has a planar embedding iff it has a planar embedding where all edges are **straight lines**.

Planar Graphs – Discussion

- Planar graphs arise in many practical applications.
- Many computational problems are **easier** for planar graphs.
 - For example, every planar graph can be **coloured** with at most 4 colours (i.e., we can assign one of four colours to each vertex such that two neighbours always have different colours).
- For this reason, planarity is of great practical interest.
- How can we **recognize** that a graph is planar?
- How can we prove that a graph is **not** planar?

Planar Graphs – Counterexample (1)

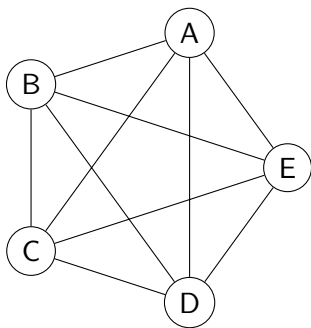

Planar Graphs – Counterexample (1)

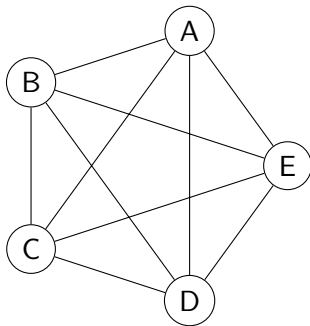

The complete graph K_5 over 5 vertices is not planar.
(We do not prove this result.)

Planar Graphs – Counterexample (2)

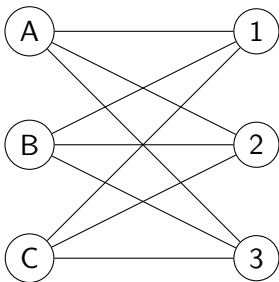

Planar Graphs – Counterexample (2)

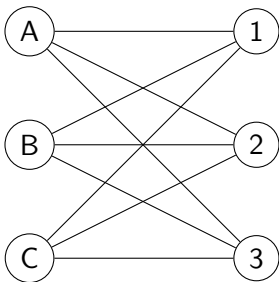

The complete bipartite graph $K_{3,3}$ over $3 + 3$ vertices is not planar.
(We do not prove this result.)

Non-Planarity in General

- The two non-planar graphs K_5 and $K_{3,3}$ are special: they are the **smallest** non-planar graphs.
- In fact, something much more powerful holds: a graph is planar **iff** it does not **contain** K_5 or $K_{3,3}$.
- The notion of **containment** we need here is related to the notion of subgraphs that we introduced, but a bit more complex. We will discuss it next.

Edge Contraction

We say that $G' = (V', E')$ can be obtained from graph $G = (V, E)$ by **contracting the edge** $\{u, v\} \in E$ if

- $V' = (V \setminus \{u, v\}) \cup \{uv\}$, where $uv \notin V$ is a new vertex
- $E' = \{e \in E \mid e \cap \{u, v\} = \emptyset\} \cup \{\{uv, w\} \mid \{u, w\} \in E \text{ or } \{v, w\} \in E\}$.

In words, we **combine** the vertices u and v (which must be connected by an edge) into a single vertex uv .

The neighbours of uv are the union of the neighbours of u and the neighbours of v .

Edge Contraction – Example

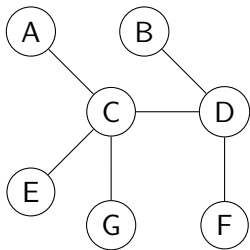

graph (V, E)

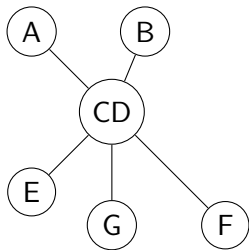

after contracting $\{C, D\}$

Minor

Definition (minor)

We say that a graph G' is a **minor** of a graph G if it can be obtained from G through a sequence of transformations of the following kind:

- 1 remove a vertex (of degree 0) from the graph
- 2 remove an edge from the graph
- 3 contract an edge in the graph

German: Minor (plural: Minoren)

Minor

Definition (minor)

We say that a graph G' is a **minor** of a graph G if it can be obtained from G through a sequence of transformations of the following kind:

- 1 remove a vertex (of degree 0) from the graph
- 2 remove an edge from the graph
- 3 contract an edge in the graph

German: Minor (plural: Minoren)

Notes:

- If we only allowed the first two transformations, we would obtain the regular subgraph relationship.
- It follows that every subgraph is a minor, but the opposite is not true in general.

Wagner's Theorem

Theorem (Wagner's Theorem)

A graph is planar iff it does not contain K_5 or $K_{3,3}$ as a minor.

German: Satz von Wagner

Note: There exist linear algorithms for testing planarity.

Minor-Hereditary Properties

- Being planar is what is called a **minor-hereditary** property: if G is planar, then all its minors are also planar.
- There exist many other important such properties.
- One example is acyclicity.

How could one prove that a property is minor-hereditary?

The Graph Minor Theorem

Theorem (Graph minor theorem)

Let Π be a minor-hereditary properties of graphs.

*Then there exists a finite set of **forbidden minors** $F(\Pi)$ such that the following result holds:*

A graph has property Π iff it does not have any graph from $F(\Pi)$ as a minor.

German: Minorentheorem

Examples:

- the forbidden minors for **planarity** are K_5 and $K_{3,3}$
- the (only) forbidden minor for **acyclicity** is K_3 ,
the complete graph with 3 vertices (a.k.a. the 3-cycle graph)

Remarks on the Graph Minor Theorem (1)

- The graph minor theorem is also known as the **Robertson-Seymour theorem**.
- It was proved by Robertson and Seymour in a series of 20 papers between 1983–2004, totalling 500+ pages.
- It is one of the most important results in graph theory.

Remarks on the Graph Minor Theorem (2)

- In principle, for every **fixed** graph H , we can test if H is a minor of a graph G in polynomial time in the size of G .
- This implies that every minor-hereditary property can be tested in polynomial time.
- However, the constant factors involved in the known general algorithms for testing minors (which depend on $|H|$) are so astronomically huge as to make them infeasible in practice.