

Planning and Optimization

D8. Merge-and-Shrink: Algorithm and Heuristic Properties

Malte Helmert and Gabriele Röger

Universität Basel

November 11, 2020

Planning and Optimization

November 11, 2020 — D8. Merge-and-Shrink: Algorithm and Heuristic Properties

D8.1 Generic Algorithm

D8.2 Example

D8.3 Heuristic Properties

D8.4 Further Topics and Literature

D8.5 Summary

Content of this Course

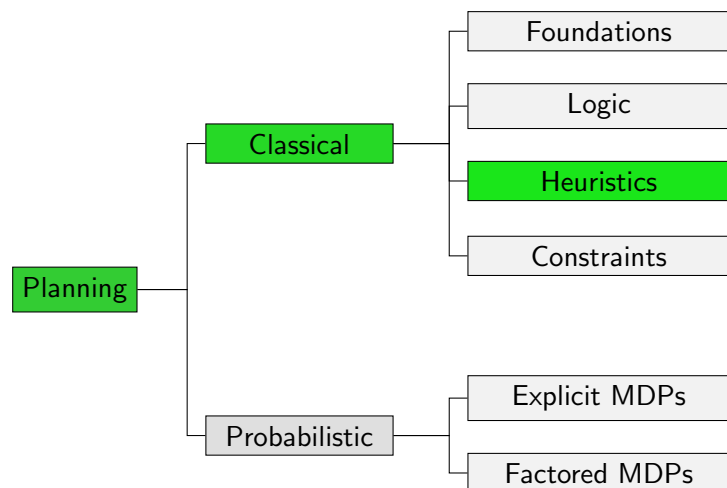

Content of this Course: Heuristics

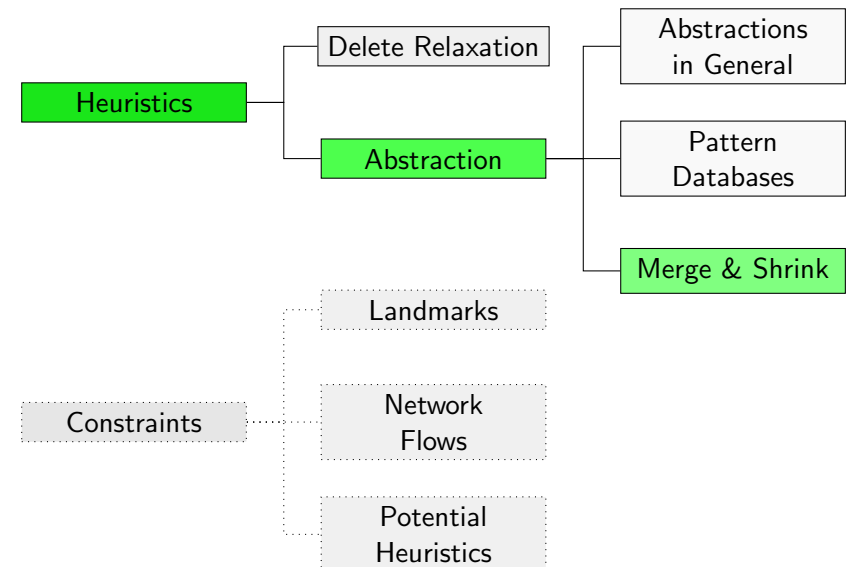

D8.1 Generic Algorithm

Generic Merge-and-shrink Abstractions: Outline

Using the results of the previous chapter, we can develop a **generic abstraction computation procedure** that **takes all state variables into account**.

- ▶ **Initialization:** Compute the FTS consisting of all atomic projections.
- ▶ **Loop:** Repeatedly apply a transformation to the FTS.
 - ▶ **Merging:** Combine two factors by replacing them with their synchronized product.
 - ▶ **Shrinking:** If the factors are too large to merge, make one of them smaller by abstracting it further (applying an arbitrary abstraction to it).
- ▶ **Termination:** Stop when only one factor is left.

The final factor is then used for an abstraction heuristic.

Generic Algorithm Template

Generic Merge & Shrink Algorithm for planning task Π

```

F := F( $\Pi$ )
while |F| > 1:
  select type  $\in$  {merge, shrink}
  if type = merge:
    select  $\mathcal{T}_1, \mathcal{T}_2 \in F$ 
    F := (F \setminus \{\mathcal{T}_1, \mathcal{T}_2\}) \cup \{\mathcal{T}_1 \otimes \mathcal{T}_2\}
  if type = shrink:
    select  $\mathcal{T} \in F$ 
    choose an abstraction mapping  $\beta$  on  $\mathcal{T}$ 
    F := (F \setminus \{\mathcal{T}\}) \cup \{\mathcal{T}^\beta\}
return the remaining factor  $\mathcal{T}^\alpha$  in F

```

Merge-and-Shrink Strategies

Choices to resolve to instantiate the template:

- ▶ When to merge, when to shrink?
↔ **general strategy**
- ▶ Which abstractions to merge?
↔ **merging strategy**
- ▶ Which abstraction to shrink, and how to shrink it (which β)?
↔ **shrinking strategy**

Choosing a Strategy

There are many possible ways to resolve these choices, and we do not cover them in detail.

A typical **general strategy**:

- ▶ define a **limit N** on the number of states allowed in each factor
- ▶ in each iteration, select two factors we would like to merge
- ▶ merge them if this does not exhaust the state number limit
- ▶ otherwise shrink one or both factors just enough to make a subsequent merge possible

Abstraction Mappings

- ▶ The pseudo-code as described only returns the final **abstract transition system** \mathcal{T}^α .
- ▶ In practice, we also need the **abstraction mapping** α , so that we can map concrete states to abstract states when we need to evaluate heuristic values.
- ▶ We do not describe in detail how this can be done.
 - ▶ Key idea: keep track of which factors are merged, which factors are shrunk and how.
 - ▶ “Replay” these decisions to map a given concrete state s to the abstract state $\alpha(s)$.
- ▶ The run-time for such a heuristic look-up is $O(|V|)$ for a task with state variables V .

D8.2 Example

Back to the Running Example

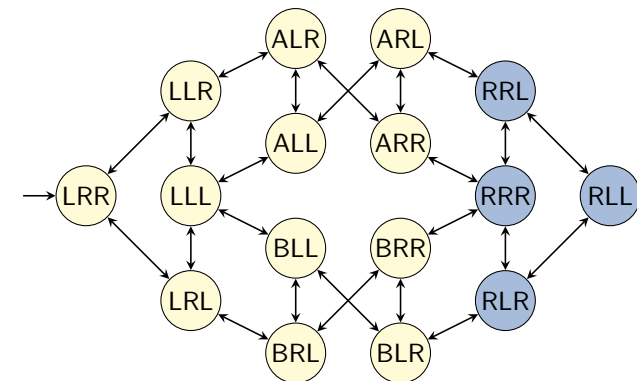

Logistics problem with one package, two trucks, two locations:

- ▶ state variable **package**: $\{L, R, A, B\}$
- ▶ state variable **truck A**: $\{L, R\}$
- ▶ state variable **truck B**: $\{L, R\}$

Initialization Step: Atomic Projection for Package

$\mathcal{T}^\pi\{\text{package}\}$:

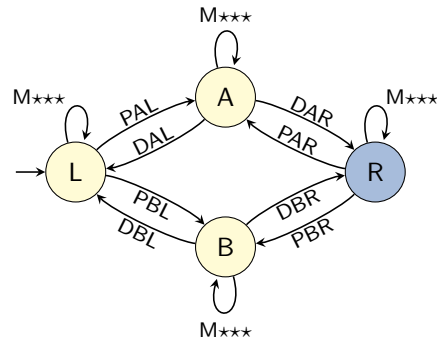

Initialization Step: Atomic Projection for Truck A

$\mathcal{T}^\pi\{\text{truck A}\}$:

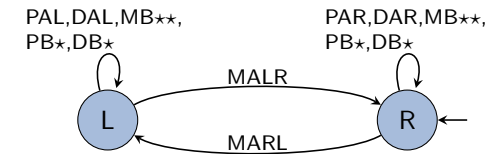

Initialization Step: Atomic Projection for Truck B

$\mathcal{T}^\pi\{\text{truck B}\}$:

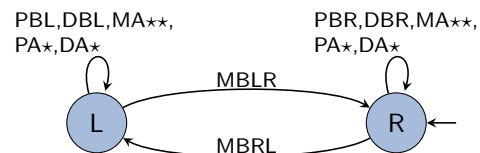

current FTS: $\{\mathcal{T}^\pi\{\text{package}\}, \mathcal{T}^\pi\{\text{truck A}\}, \mathcal{T}^\pi\{\text{truck B}\}\}$

First Merge Step

$\mathcal{T}_1 := \mathcal{T}^\pi\{\text{package}\} \otimes \mathcal{T}^\pi\{\text{truck A}\}$:

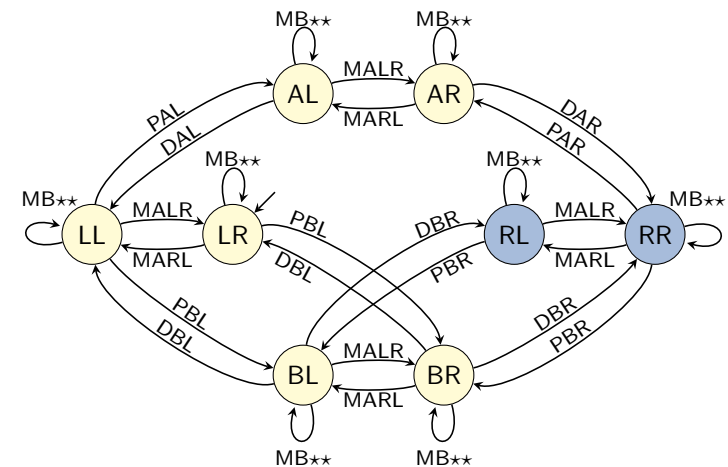

current FTS: $\{\mathcal{T}_1, \mathcal{T}^\pi\{\text{truck B}\}\}$

Need to Shrink?

- ▶ With sufficient memory, we could now compute $\mathcal{T}_1 \otimes \mathcal{T}^{\pi_{\{\text{truck B}\}}}$ and recover the full transition system of the task.
- ▶ However, to illustrate the general idea, we assume that memory is too restricted: we may never create a factor with more than **8 states**.
- ▶ To make the product fit the bound, we shrink \mathcal{T}_1 to 4 states. We can decide freely **how exactly** to abstract \mathcal{T}_1 .
- ▶ In this example, we manually choose an abstraction that leads to a good result in the end. Making good shrinking decisions algorithmically is the job of the **shrinking strategy**.

First Shrink Step

$\mathcal{T}_2 := \text{some abstraction of } \mathcal{T}_1$

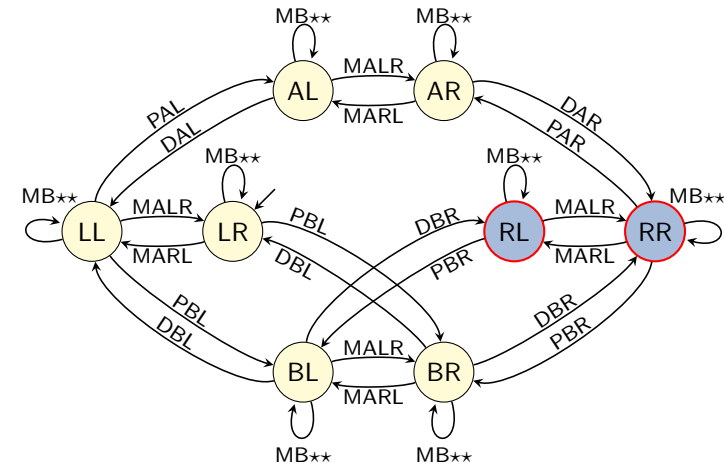

First Shrink Step

$\mathcal{T}_2 := \text{some abstraction of } \mathcal{T}_1$

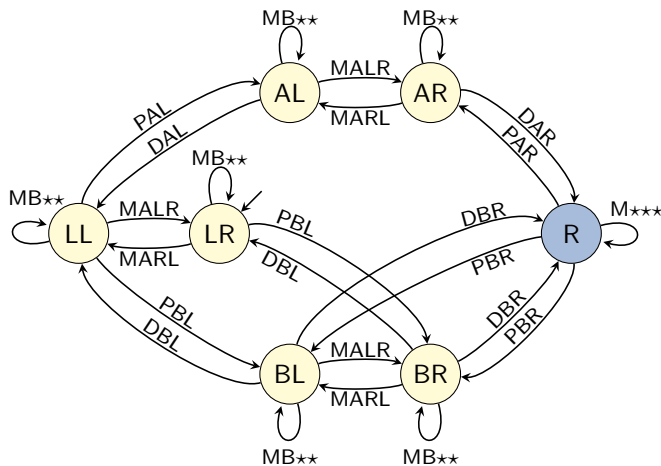

First Shrink Step

$\mathcal{T}_2 := \text{some abstraction of } \mathcal{T}_1$

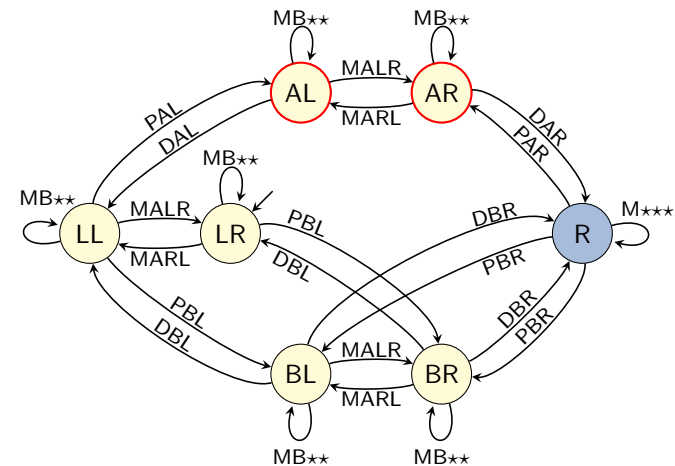

First Shrink Step

$\mathcal{T}_2 := \text{some abstraction of } \mathcal{T}_1$

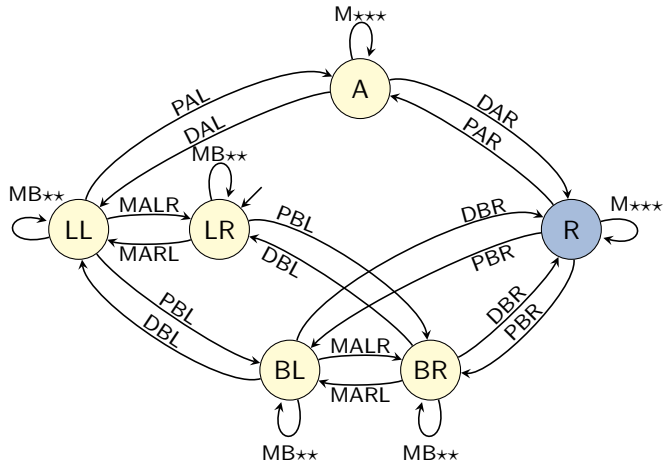

First Shrink Step

$\mathcal{T}_2 := \text{some abstraction of } \mathcal{T}_1$

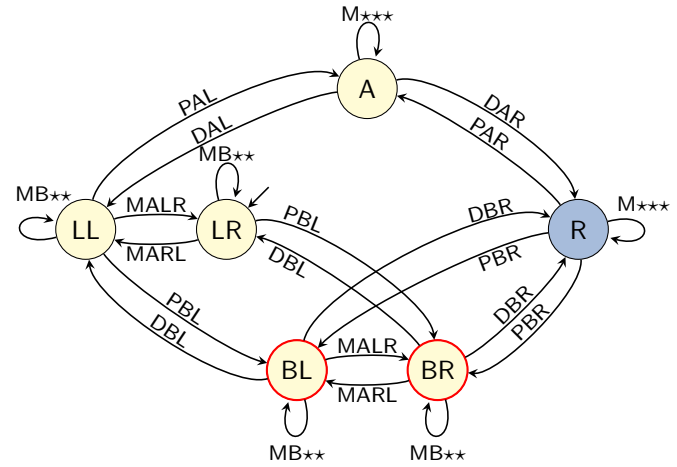

First Shrink Step

$\mathcal{T}_2 := \text{some abstraction of } \mathcal{T}_1$

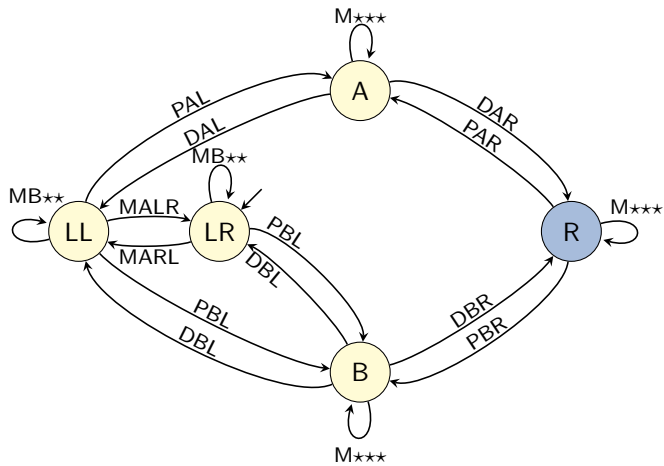

First Shrink Step

$\mathcal{T}_2 := \text{some abstraction of } \mathcal{T}_1$

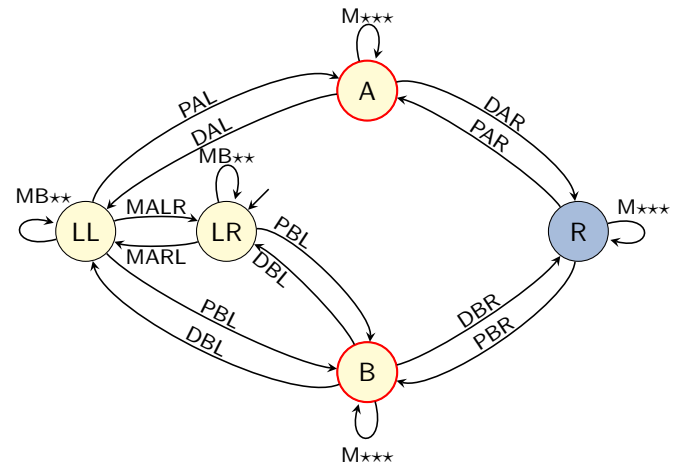

First Shrink Step

$\mathcal{T}_2 :=$ some abstraction of \mathcal{T}_1

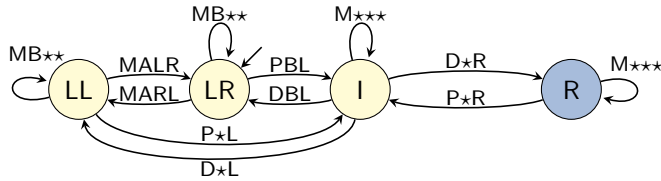

First Shrink Step

$\mathcal{T}_2 :=$ some abstraction of \mathcal{T}_1

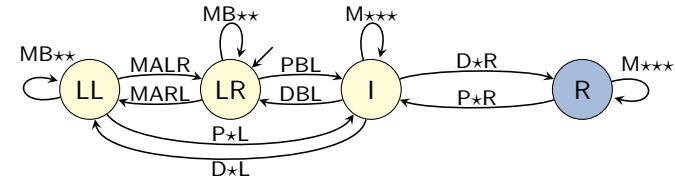

current FTS: $\{\mathcal{T}_2, \mathcal{T}^{\pi}_{\{\text{truck B}\}}\}$

Second Merge Step

$\mathcal{T}_3 := \mathcal{T}_2 \otimes \mathcal{T}^{\pi}_{\{\text{truck B}\}}:$

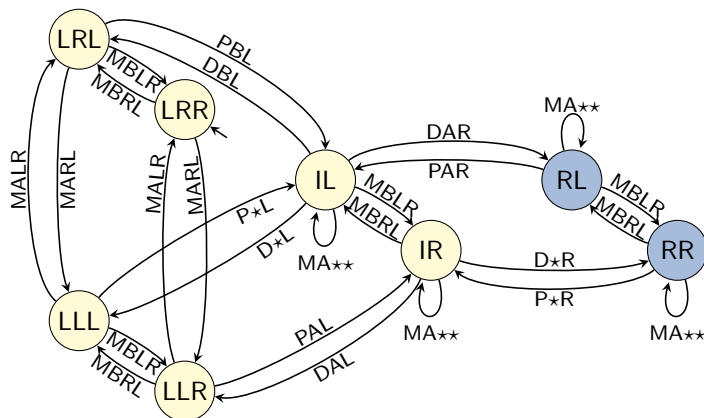

current FTS: $\{\mathcal{T}_3\}$

Another Shrink Step?

- ▶ At this point, merge-and-shrink construction stops. The distances in the final factor define the heuristic function.
- ▶ If there were further state variables to integrate, we would shrink again, e.g., leading to the following abstraction (again with four states):

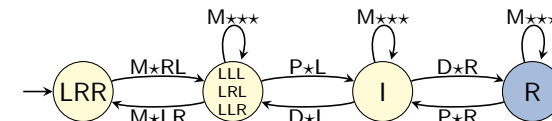

- ▶ We get a heuristic value of 3 for the initial state, **better than any PDB heuristic** that is a proper abstraction.
- ▶ The example generalizes to arbitrarily many trucks, even if we stick to the fixed size limit of 8.

D8.3 Heuristic Properties

Properties of Merge-and-Shrink Heuristics

To understand merge-and-shrink abstractions better, we are interested in the **properties** of the resulting heuristic:

- ▶ Is it **admissible** ($h^\alpha(s) \leq h^*(s)$ for all states s)?
- ▶ Is it **consistent** ($h^\alpha(s) \leq c(o) + h^\alpha(t)$ for all trans. $s \xrightarrow{o} t$)?
- ▶ Is it **perfect** ($h^\alpha(s) = h^*(s)$ for all states s)?

Because merge-and-shrink is a **generic** procedure, the answers may depend on how exactly we instantiate it:

- ▶ size limits
- ▶ merge strategy
- ▶ shrink strategy

Merge-and-Shrink as Sequence of Transformations

- ▶ Consider a run of the merge-and-shrink construction algorithm with n iterations of the main loop.
- ▶ Let F_i ($0 \leq i \leq n$) be the FTS F after i loop iterations.
- ▶ Let \mathcal{T}_i ($0 \leq i \leq n$) be the transition system **represented** by F_i , i.e., $\mathcal{T}_i = \otimes F_i$.
- ▶ In particular, $F_0 = F(\Pi)$ and $F_n = \{T_n\}$.
- ▶ For SAS⁺ tasks Π , we also know $\mathcal{T}_0 = \mathcal{T}(\Pi)$.

For a formal study, it is useful to view merge-and-shrink construction as a sequence of **transformations** from \mathcal{T}_i to \mathcal{T}_{i+1} .

Transformations

Definition (Transformation)

Let $\mathcal{T} = \langle S, L, c, T, s_0, S_* \rangle$ and $\mathcal{T}' = \langle S', L, c, T', s'_0, S'_* \rangle$

be transition systems with the same labels and costs.

Let $\sigma : S \rightarrow S'$ map the states of \mathcal{T} to the states of \mathcal{T}' .

The triple $\tau = \langle \mathcal{T}, \sigma, \mathcal{T}' \rangle$ is called a **transformation** from \mathcal{T} to \mathcal{T}' .

We also write it as $\mathcal{T} \xrightarrow{\sigma} \mathcal{T}'$.

The transformation τ induces the **heuristic** h^τ for \mathcal{T} defined as $h^\tau(s) = h_{\mathcal{T}'}^*(\sigma(s))$.

Example: If α is an abstraction mapping for transition system \mathcal{T} , then $\mathcal{T} \xrightarrow{\alpha} \mathcal{T}^\alpha$ is a transformation.

Special Transformations

- ▶ A transformation $\tau = \mathcal{T} \xrightarrow{\sigma} \mathcal{T}'$ is called **conservative** if it corresponds to an abstraction, i.e., if $\mathcal{T}' = \mathcal{T}^\sigma$.
- ▶ A transformation $\tau = \mathcal{T} \xrightarrow{\sigma} \mathcal{T}'$ is called **exact** if it induces the perfect heuristic, i.e., if $h^\tau(s) = h^*(s)$ for all states s of \mathcal{T} .

Merge transformations are always conservative and exact.

Shrink transformations are always conservative.

Composing Transformations

Merge-and-shrink performs many transformations in sequence.

We can formalize this with a notion of **composition**:

- ▶ Given $\tau = \mathcal{T} \xrightarrow{\sigma} \mathcal{T}'$ and $\tau' = \mathcal{T}' \xrightarrow{\sigma'} \mathcal{T}''$, their **composition** $\tau'' = \tau' \circ \tau$ is defined as $\tau'' = \mathcal{T} \xrightarrow{\sigma' \circ \sigma} \mathcal{T}''$.
- ▶ If τ and τ' are conservative, then $\tau' \circ \tau$ is conservative.
- ▶ If τ and τ' are exact, then $\tau' \circ \tau$ is exact.

Properties of Merge-and-Shrink Heuristics

We can conclude the following properties of merge-and-shrink heuristics for SAS^+ tasks:

- ▶ The heuristic is always **admissible** and **consistent** (because it is induced by a composition of conservative transformations and therefore an abstraction).
- ▶ If all shrink transformation used are exact, the heuristic is **perfect** (because it is induced by a composition of exact transformations).

D8.4 Further Topics and Literature



Further Topics in Merge and Shrink

Further topics in merge-and-shrink abstraction:

- ▶ how to keep track of the abstraction mapping
- ▶ efficient implementation
- ▶ concrete merge strategies
 - ▶ often focus on goal variables and causal connectivity (similar to hill-climbing for pattern selection)
 - ▶ sometimes based on mutexes or symmetries
- ▶ concrete shrink strategies
 - ▶ especially: h -preserving, f -preserving, bisimulation-based
 - ▶ (some) bisimulation-based shrinking strategies are exact
- ▶ other transformations besides merging and shrinking
 - ▶ especially: pruning and label reduction

Literature (1)



References on merge-and-shrink abstractions:

-  Klaus Dräger, Bernd Finkbeiner and Andreas Podelski. Directed Model Checking with Distance-Preserving Abstractions. *Proc. SPIN 2006*, pp. 19–34, 2006. Introduces merge-and-shrink abstractions (for model checking).
-  Malte Helmert, Patrik Haslum and Jörg Hoffmann. Flexible Abstraction Heuristics for Optimal Sequential Planning. *Proc. ICAPS 2007*, pp. 176–183, 2007. Introduces merge-and-shrink abstractions for planning.

Literature (2)

-  Raz Nissim, Jörg Hoffmann and Malte Helmert. Computing Perfect Heuristics in Polynomial Time: On Bisimulation and Merge-and-Shrink Abstractions in Optimal Planning. *Proc. IJCAI 2011*, pp. 1983–1990, 2011. Introduces bisimulation-based shrinking.
-  Malte Helmert, Patrik Haslum, Jörg Hoffmann and Raz Nissim. Merge-and-Shrink Abstraction: A Method for Generating Lower Bounds in Factored State Spaces. *Journal of the ACM 61 (3)*, pp. 16:1–63, 2014. Detailed journal version of the previous two publications.

Literature (3)

-  Silvan Sievers, Martin Wehrle and Malte Helmert. Generalized Label Reduction for Merge-and-Shrink Heuristics. *Proc. AAAI 2014*, pp. 2358–2366, 2014. Introduces modern version of label reduction. (There was a more complicated version before.)
-  Gaojian Fan, Martin Müller and Robert Holte. Non-linear merging strategies for merge-and-shrink based on variable interactions. *Proc. SoCS 2014*, pp. 53–61, 2014. Introduces UMC and MIASM merging strategies

D8.5 Summary

Summary (1)

- ▶ Merge-and-shrink abstractions are constructed by iteratively **transforming** the factored transition system of a planning task.
- ▶ **Merge** transformations combine two factors into their synchronized product.
- ▶ **Shrink** transformations reduce the size of a factor by abstracting it.

Summary (2)

- ▶ Projections of SAS^+ tasks correspond to merges of atomic factors.
- ▶ By also including shrinking, merge-and-shrink abstractions **generalize** projections: they can reflect **all** state variables, but in a potentially **lossy** way.

Summary (3)

- ▶ Merge-and-shrink abstractions can be analyzed by viewing them as a sequence of **transformations**.
- ▶ We only use **conservative transformations**, and hence merge-and-shrink heuristics for SAS^+ tasks are **admissible** and **consistent**.
- ▶ Merge-and-shrink heuristics for SAS^+ tasks that only use **exact** transformations are **perfect**.