

Theory of Computer Science

B9. Context-free Languages: Push-Down Automata

Gabriele Röger

University of Basel

March 25, 2026

Theory of Computer Science

March 25, 2026 — B9. Context-free Languages: Push-Down Automata

B9.1 Push-Down Automata

B9.1 Push-Down Automata

Content of the Course

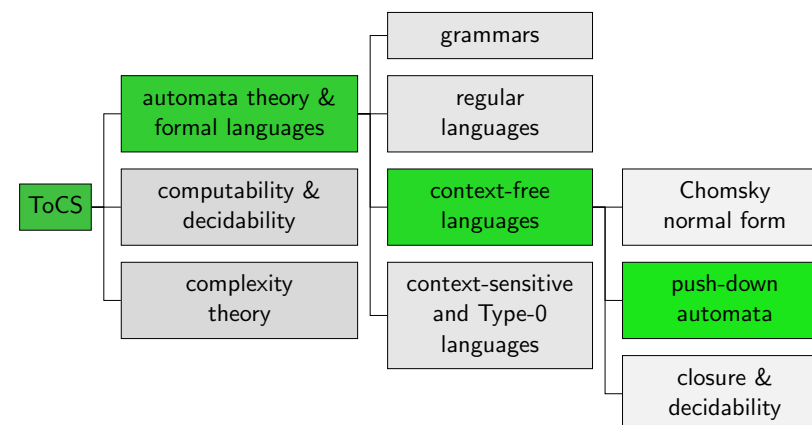

Limitations of Finite Automata

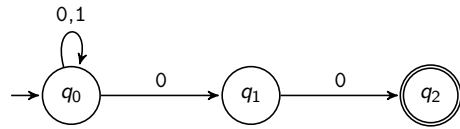

- ▶ Language L is regular.
 \iff There is a finite automaton that recognizes L .
- ▶ What information can a finite automaton “store” about the already read part of the word?
- ▶ Infinite memory would be required for $L = \{x_1x_2 \dots x_nx_n \dots x_2x_1 \mid n > 0, x_i \in \{a, b\}\}$.
- ▶ therefore: extension of the automata model with memory

Stack

A **stack** is a data structure following the **last-in-first-out (LIFO)** principle supporting the following operations:

- ▶ **push**: puts an object on top of the stack
- ▶ **pop**: removes the object at the top of the stack
- ▶ **peek**: returns the top object without removing it

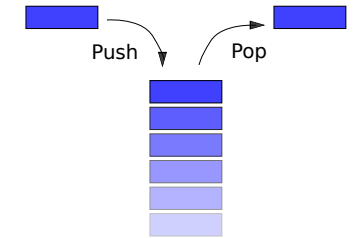

German: Keller, Stapel

Push-down Automata: Visually

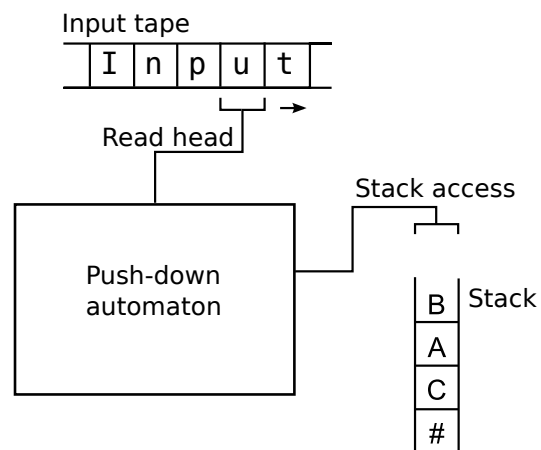

German: Kellerautomat, Eingabeband, Lesekopf, Kellerzugriff

Push-down Automaton for $\{a^n b^n \mid n \in \mathbb{N}_0\}$: Idea

- ▶ As long as you read symbols a , push an A on the stack.
- ▶ As soon as you read a symbol b , pop an A off the stack as long as you read b .
- ▶ If reading the input is finished exactly when the stack becomes empty, accept the input.
- ▶ If there is no A to pop when reading a b , or there is still an A on the stack after reading all input symbols, or if you read an a following a b then reject the input.

Push-down Automata: Non-determinism

- ▶ PDAs are **non-deterministic** and can allow several next transitions from a configuration.
- ▶ Like NFAs, PDAs can have transitions that do not read a symbol from the input.
- ▶ Similarly, there can be transitions that do not pop and/or push a symbol off/to the stack.

Deterministic variants of PDAs are strictly less expressive, i. e. there are languages that can be recognized by a (non-deterministic) PDA but not the deterministic variant.

Push-down Automaton for $\{a^n b^n \mid n \in \mathbb{N}_0\}$: Diagram

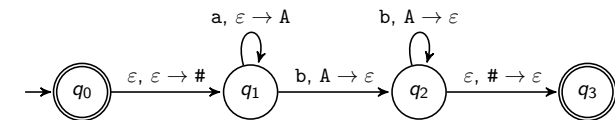

Push-down Automata: Definition

Definition (Push-down Automaton)

A **push-down automaton (PDA)** is a 6-tuple $M = \langle Q, \Sigma, \Gamma, \delta, q_0, F \rangle$ with

- ▶ Q finite set of states
- ▶ Σ the input alphabet
- ▶ Γ the stack alphabet
- ▶ $\delta : Q \times (\Sigma \cup \{\varepsilon\}) \times (\Gamma \cup \{\varepsilon\}) \rightarrow \mathcal{P}(Q \times (\Gamma \cup \{\varepsilon\}))$ the transition function
- ▶ $q_0 \in Q$ the start state
- ▶ $F \subseteq Q$ is the set of **accept states**

German: Kellerautomat, Eingabealphabet, Kelleralphabet, Überföhrungsfunktion

Push-down Automata: Transition Function

Let $M = \langle Q, \Sigma, \Gamma, \delta, q_0, F \rangle$ be a push-down automaton.

What is the Intuitive Meaning of the Transition Function δ ?

- ▶ $\langle q', B \rangle \in \delta(q, a, A)$: If M is in state q , reads symbol a and has A as the topmost stack symbol, then M **can** transition to q' in the next step popping A off the stack and pushing B on the stack.

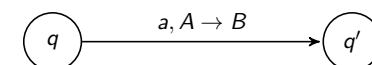

- ▶ special case $a = \varepsilon$ is allowed (spontaneous transition)
- ▶ special case $A = \varepsilon$ is allowed (no pop)
- ▶ special case $B = \varepsilon$ is allowed (no push)

Push-down Automaton for $\{a^n b^n \mid n \in \mathbb{N}_0\}$: Formally

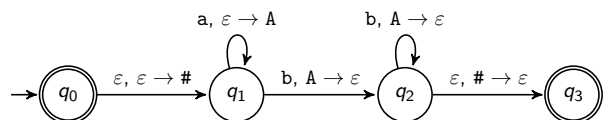

$M = \langle \{q_0, q_1, q_2, q_3\}, \{a, b\}, \{A, \#\}, \delta, q_0, \{q_0, q_3\} \rangle$ with

$\delta(q_0, a, A) = \emptyset$	$\delta(q_0, b, A) = \emptyset$	$\delta(q_0, \varepsilon, A) = \emptyset$
$\delta(q_0, a, \#) = \emptyset$	$\delta(q_0, b, \#) = \emptyset$	$\delta(q_0, \varepsilon, \#) = \emptyset$
$\delta(q_0, a, \varepsilon) = \emptyset$	$\delta(q_0, b, \varepsilon) = \emptyset$	$\delta(q_0, \varepsilon, \varepsilon) = \{(q_1, \#)\}$
$\delta(q_1, a, A) = \emptyset$	$\delta(q_1, b, A) = \{(q_2, \varepsilon)\}$	$\delta(q_1, \varepsilon, A) = \emptyset$
$\delta(q_1, a, \#) = \emptyset$	$\delta(q_1, b, \#) = \emptyset$	$\delta(q_1, \varepsilon, \#) = \emptyset$
$\delta(q_1, a, \varepsilon) = \{(q_1, A)\}$	$\delta(q_1, b, \varepsilon) = \emptyset$	$\delta(q_1, \varepsilon, \varepsilon) = \emptyset$
$\delta(q_2, a, A) = \emptyset$	$\delta(q_2, b, A) = \{(q_2, \varepsilon)\}$	$\delta(q_2, \varepsilon, A) = \emptyset$
$\delta(q_2, a, \#) = \emptyset$	$\delta(q_2, b, \#) = \emptyset$	$\delta(q_2, \varepsilon, \#) = \{(q_3, \varepsilon)\}$
$\delta(q_2, a, \varepsilon) = \emptyset$	$\delta(q_2, b, \varepsilon) = \emptyset$	$\delta(q_2, \varepsilon, \varepsilon) = \emptyset$

and $\delta(q_3, x, y) = \emptyset$ for all $x \in \{a, b, \varepsilon\}$, $y \in \{A, \#, \varepsilon\}$

13 / 20

Push-down Automata: Accepted Words

Definition

A PDA $M = \langle Q, \Sigma, \Gamma, \delta, q_0, F \rangle$ **accepts input w** if it can be written as $w = w_1 w_2 \dots w_m$ where each $w_i \in \Sigma \cup \{\varepsilon\}$ and sequences of states $r_0, r_1, \dots, r_m \in Q$ and strings $s_0, s_1, \dots, s_m \in \Gamma^*$ exist that satisfy the following three conditions:

- 1 $r_0 = q_0$ and $s_0 = \varepsilon$
- 2 For $i = 0, \dots, m - 1$, we have $(r_{i+1}, b) \in \delta(r_i, w_{i+1}, a)$, where $s_i = at$ and $s_{i+1} = bt$ for some $a, b \in \Gamma \cup \{\varepsilon\}$ and $t \in \Gamma^*$.
- 3 $r_m \in F$

The strings s_i represent the sequence of stack contents.

14 / 20

Push-down Automaton for $\{a^n b^n \mid n \in \mathbb{N}_0\}$

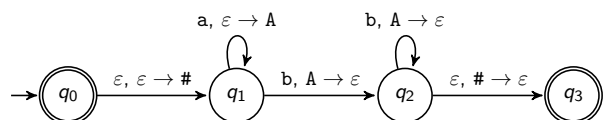

The PDA accepts input aabb.

15 / 20

PDA: Recognized Language

Definition (Language Recognized by an PDA)

Let M be a PDA with input alphabet Σ .

The **language recognized by M** is defined as

$$\mathcal{L}(M) = \{w \in \Sigma^* \mid w \text{ is accepted by } M\}.$$

16 / 20

Recognized Language: Exercise

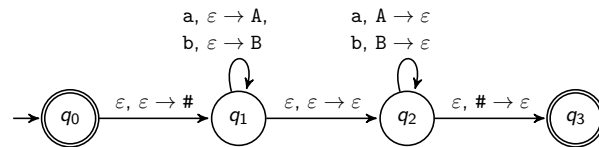

What language does this PDA recognize?

PDA's Recognize Exactly the Context-free Languages

Theorem

A language L is context-free if and only if L is recognized by a push-down automaton.

PDA's: Exercise (if time)

Assume you want to have a possible transition from state q to state q' in your PDA that

- ▶ processes symbol c from the input word,
- ▶ can only be taken if the top stack symbol is A ,
- ▶ does **not** pop A off the stack, and
- ▶ pushes B .



What problem do you encounter? How can you work around it?

Summary

- ▶ **Push-down automata** (PDAs) extend NFAs with memory (only stack access)
- ▶ The **languages recognized by PDAs** are exactly the **context-free languages**.