

Theory of Computer Science

B6. Regular Languages: Regular Expressions

Gabriele Röger

University of Basel

March 20, 2024

Regular Expressions

Content of the Course

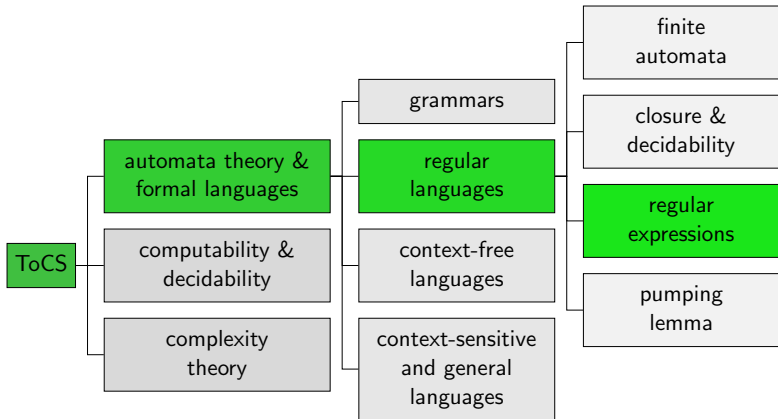

Formalisms for Regular Languages

- DFAs, NFAs and regular grammars can all describe exactly the regular languages.
- Are there other concepts with the same expressiveness?
- **Yes!** \rightsquigarrow regular expressions

Formalisms for Regular Languages

- DFAs, NFAs and regular grammars can all describe exactly the regular languages.
- Are there other concepts with the same expressiveness?
- **Yes!** \rightsquigarrow regular expressions

\rightsquigarrow see it in the RealWorld™

Reminder: Concatenation of Languages and Kleene Star

Concatenation

- For two languages L_1 (over Σ_1) and L_2 (over Σ_2), the **concatenation** of L_1 and L_2 is the language $L_1L_2 = \{w_1w_2 \in (\Sigma_1 \cup \Sigma_2)^* \mid w_1 \in L_1, w_2 \in L_2\}$.

Reminder: Concatenation of Languages and Kleene Star

Concatenation

- For two languages L_1 (over Σ_1) and L_2 (over Σ_2), the **concatenation** of L_1 and L_2 is the language $L_1L_2 = \{w_1w_2 \in (\Sigma_1 \cup \Sigma_2)^* \mid w_1 \in L_1, w_2 \in L_2\}$.

Kleene star

- For language L define
 - $L^0 = \{\varepsilon\}$
 - $L^1 = L$
 - $L^{i+1} = L^iL$ for $i \in \mathbb{N}_{>0}$
- The definition of Kleene star on L is $L^* = \bigcup_{i \geq 0} L^i$.

Regular Expressions: Definition

Definition (Regular Expressions)

Regular expressions over an alphabet Σ are defined inductively:

- \emptyset is a regular expression
- ε is a regular expression
- If $a \in \Sigma$, then a is a regular expression

If α and β are regular expressions, then so are:

- $(\alpha\beta)$ (**concatenation**)
- $(\alpha|\beta)$ (**alternative**)
- (α^*) (**Kleene closure**)

Regular Expressions: Omitting Parentheses

omitted parentheses by convention:

- Kleene closure α^* binds more strongly than concatenation $\alpha\beta$.
- Concatenation binds more strongly than alternative $\alpha|\beta$.
- Parentheses for nested concatenations/alternatives are omitted (we can treat them as left-associative; it does not matter).

Example: $ab^*c|\varepsilon|abab^*$ abbreviates $((((a(b^*))c)|\varepsilon)|(((ab)a)(b^*)))$.

Regular Expressions: Examples

some regular expressions for $\Sigma = \{0, 1\}$:

- 0^*10^*
- $(0|1)^*1(0|1)^*$
- $((0|1)(0|1))^*$
- $01|10$
- $0(0|1)^*0|1(0|1)^*1|0|1$

Regular Expressions: Language

Definition (Language Described by a Regular Expression)

The **language described by a regular expression** γ , written $\mathcal{L}(\gamma)$, is inductively defined as follows:

- If $\gamma = \emptyset$, then $\mathcal{L}(\gamma) = \emptyset$.
- If $\gamma = \varepsilon$, then $\mathcal{L}(\gamma) = \{\varepsilon\}$.
- If $\gamma = a$ with $a \in \Sigma$, then $\mathcal{L}(\gamma) = \{a\}$.
- If $\gamma = (\alpha\beta)$, where α and β are regular expressions, then $\mathcal{L}(\gamma) = \mathcal{L}(\alpha)\mathcal{L}(\beta)$.
- If $\gamma = (\alpha|\beta)$, where α and β are regular expressions, then $\mathcal{L}(\gamma) = \mathcal{L}(\alpha) \cup \mathcal{L}(\beta)$.
- If $\gamma = (\alpha^*)$ where α is a regular expression, then $\mathcal{L}(\gamma) = \mathcal{L}(\alpha)^*$.

Examples: blackboard

Regular Expressions: Exercise

Specify a regular expression that describes

$L = \{w \in \{0, 1\}^* \mid \text{every } 0 \text{ in } w \text{ is followed by at least one } 1\}$.



Questions



Questions?

Regular Expressions vs. Regular Languages

Finite Languages Can Be Described By Regular Expressions

Theorem

*Every **finite** language can be described by a regular expression.*

Finite Languages Can Be Described By Regular Expressions

Theorem

Every *finite* language can be described by a regular expression.

Proof.

For every word $w \in \Sigma^*$, a regular expression describing the language $\{w\}$ can be built from regular expressions $a \in \Sigma$ by using concatenations.

(Use ε if $w = \varepsilon$.)

Finite Languages Can Be Described By Regular Expressions

Theorem

Every *finite* language can be described by a regular expression.

Proof.

For every word $w \in \Sigma^*$, a regular expression describing the language $\{w\}$ can be built from regular expressions $a \in \Sigma$ by using concatenations.

(Use ε if $w = \varepsilon$.)

For every finite language $L = \{w_1, w_2, \dots, w_n\}$, a regular expression describing L can be built from the regular expressions for $\{w_i\}$ by using alternatives.

(Use \emptyset if $L = \emptyset$.)



Finite Languages Can Be Described By Regular Expressions

Theorem

Every *finite* language can be described by a regular expression.

Proof.

For every word $w \in \Sigma^*$, a regular expression describing the language $\{w\}$ can be built from regular expressions $a \in \Sigma$ by using concatenations.

(Use ε if $w = \varepsilon$.)

For every finite language $L = \{w_1, w_2, \dots, w_n\}$, a regular expression describing L can be built from the regular expressions for $\{w_i\}$ by using alternatives.

(Use \emptyset if $L = \emptyset$.)



We will see that this implies that all finite languages are regular.

Regular Expressions Not More Powerful Than NFAs

Theorem

For every language that can be described by a regular expression, there is an NFA that recognizes it.

Regular Expressions Not More Powerful Than NFAs

Theorem

For every language that can be described by a regular expression, there is an NFA that recognizes it.

Proof.

Let γ be a regular expression.

We show the statement by induction over the structure of regular expressions.

Regular Expressions Not More Powerful Than NFAs

Theorem

For every language that can be described by a regular expression, there is an NFA that recognizes it.

Proof.

Let γ be a regular expression.

We show the statement by induction over the structure of regular expressions.

For $\gamma = \emptyset$, $\gamma = \varepsilon$ and $\gamma = a$, the following three NFAs recognize $\mathcal{L}(\gamma)$:

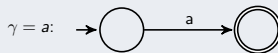
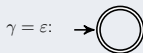

Regular Expressions Not More Powerful Than NFAs

Theorem

For every language that can be described by a regular expression, there is an NFA that recognizes it.

Proof.

Let γ be a regular expression.

We show the statement by induction over the structure of regular expressions.

For $\gamma = \emptyset$, $\gamma = \varepsilon$ and $\gamma = a$, the following three NFAs recognize $\mathcal{L}(\gamma)$:

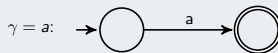
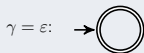
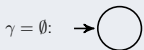

For $\gamma = (\alpha\beta)$, $\gamma = (\alpha|\beta)$ and $\gamma = (\alpha^*)$ we use the constructions that we used to show that the regular languages are closed under concatenation, union, and star, respectively. □

Regular Expression to NFA: Exercise

Construct an NFA that recognizes the language that is described by the regular expression $(ab|a)^*$.



DFAs Not More Powerful Than Regular Expressions

Theorem

Every language recognized by a DFA can be described by a regular expression.

DFAs Not More Powerful Than Regular Expressions

Theorem

Every language recognized by a DFA can be described by a regular expression.

We can prove this using a generalization of NFAs.

We specify the corresponding algorithm.

Generalized Nondeterministic Finite Automata (GNFAs)

GNFAs are like NFAs but the transition labels can be arbitrary regular expressions over the input alphabet.

For convenience, we require a special form:

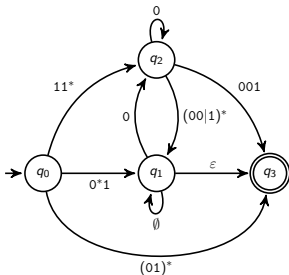

- The start state has a transition to every other state but no incoming one.
- One accept state (\neq start state)
- The accept state has an incoming transition from every other state but no outgoing one.
- For all other states, one transition goes from every state to every other state and also to itself.

Generalized Nondeterministic Finite Automaton: Definition

Definition (Generalized Nondeterministic Finite Automata)

A **generalized nondeterministic finite automaton (GNFA)** is a 5-tuple $M = \langle Q, \Sigma, \delta, q_s, q_a \rangle$ where

- Q is the finite set of **states**
- Σ is the **input alphabet**
- $\delta : (Q \setminus \{q_a\}) \times (Q \setminus \{q_s\}) \rightarrow \mathcal{R}_\Sigma$ is the transition function (with \mathcal{R}_Σ the set of all regular expressions over Σ)
- $q_s \in Q$ is the **start state**
- $q_a \in Q$ is the **accept state** with $q_a \neq q_s$.

GNFA: Accepted Words

Definition (Words Accepted by a GNFA)

GNFA $M = \langle Q, \Sigma, \delta, q_s, q_a \rangle$ **accepts the word** w

if $w = w_1 \dots w_k$, where each w_i is in Σ^*

and a sequence of states $q_0, q_1, \dots, q_k \in Q$ exists with

- 1 $q_0 = q_s$,
- 2 for each i , we have $w_i \in \mathcal{L}(R_i)$, where $R_i = \delta(q_{i-1}, q_i)$, and
- 3 $q_k = q_a$.

DFA to GNFA

We can transform every DFA into a GNFA of the special form:

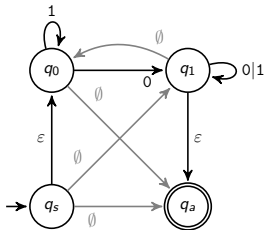
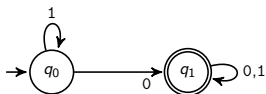

- Add a new start state with an ϵ -transition to the original start state.
- Add a new accept state with ϵ -transitions from the original accept states.
- Combine parallel transitions into one, labelled with the alternative of the original labels.
- If required transitions are missing, add transitions labelled with \emptyset .

Conversion of GNFA to a Regular Expressions

Convert($M = \langle Q, \Sigma, \delta, q_s, q_a \rangle$)

- 1 If $|Q| = 2$ return $\delta(q_s, q_a)$.
- 2 Select any state $q \in Q \setminus \{q_s, q_a\}$ and let $M' = \langle Q \setminus \{q\}, \Sigma, \delta', q_s, q_a \rangle$, where for any $q_i \neq q_a$ and $q_j \neq q_s$ we define

$$\delta'(q_i, q_j) = (\gamma_1)(\gamma_2)^*(\gamma_3)|(\gamma_4)$$

with

$$\gamma_1 = \delta(q_i, q), \gamma_2 = \delta(q, q), \gamma_3 = \delta(q, q_j), \gamma_4 = \delta(q_i, q_j).$$

- 3 Return Convert(M')

Example

For DFA:

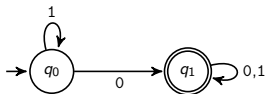

Example

For DFA:

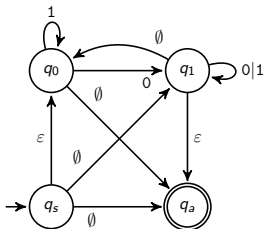
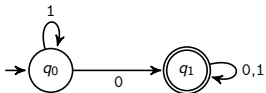

Example

For DFA:

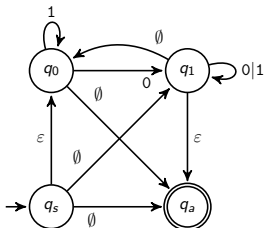
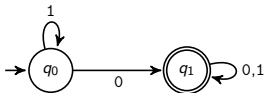

⇒

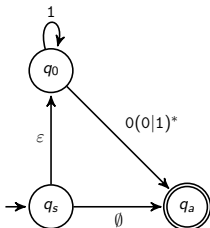

Example

For DFA:

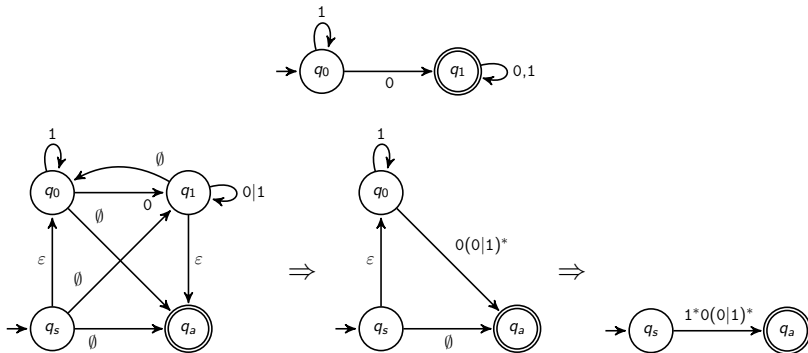

Example

For DFA:

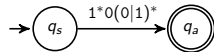
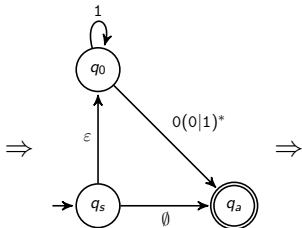
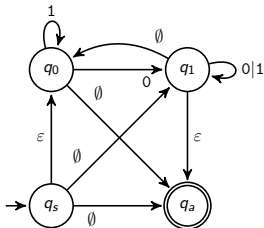
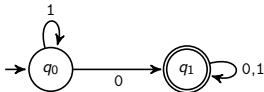

Regular expression: $1^*0(0|1)^*$

Regular Languages vs. Regular Expressions

Theorem (Kleene)

The set of languages that can be described by regular expressions is exactly the set of regular languages.

This follows directly from the previous two theorems.

Questions

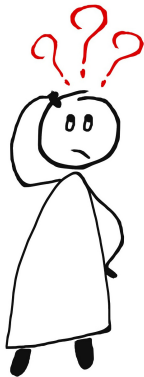

Questions?

Summary

Summary

- **Regular expressions** are another way to describe languages.
- All regular languages can be described by regular expressions, and all regular expressions describe regular languages.
- Hence, they are equivalent to finite automata.