

Foundations of Artificial Intelligence

F4. Automated Planning: Delete Relaxation Heuristics

Malte Helmert

University of Basel

May 6, 2024

Automated Planning: Overview

Chapter overview: automated planning

- F1. Introduction
- F2. Planning Formalisms
- F3. Delete Relaxation
- F4. Delete Relaxation Heuristics
- F5. Abstraction
- F6. Abstraction Heuristics

Relaxed Planning Graphs

Relaxed Planning Graphs

- **relaxed planning graphs**: represent **which** variables in Π^+ can be reached and **how**
- graphs with **variable layers** V^i and **action layers** A^i
 - variable layer V^0 contains the **variable vertex** v^0 for all $v \in I$
 - action layer A^{i+1} contains the **action vertex** a^{i+1} for action a if V^i contains the vertex v^i for all $v \in \text{pre}(a)$
 - variable layer V^{i+1} contains the variable vertex v^{i+1} if previous variable layer contains v^i , or previous action layer contains a^{i+1} with $v \in \text{add}(a)$

German: relaxierter Planungsgraph, Variablenknoten, Aktionsknoten

Relaxed Planning Graphs (Continued)

- a **goal vertex** g if $v^n \in V^n$ for all $v \in G$, where n is last layer
- graph can be constructed for arbitrary many layers but stabilizes after a bounded number of layers
 $\rightsquigarrow V^{i+1} = V^i$ and $A^{i+1} = A^i$ (Why?)
- directed edges:
 - from v^i to a^{i+1} if $v \in pre(a)$ (**precondition edges**)
 - from a^i to v^i if $v \in add(a)$ (**effect edges**)
 - from v^i to v^{i+1} (**no-op edges**)
 - from v^n to g if $v \in G$ (**goal edges**)

German: Zielknoten, Vorbedingungskanten, Effektkanten, Zielkanten, No-Op-Kanten

Illustrative Example

We write actions a with $pre(a) = \{p_1, \dots, p_k\}$,
 $add(a) = \{q_1, \dots, q_l\}$, $del(a) = \emptyset$ and $cost(a) = c$
as $p_1, \dots, p_k \xrightarrow{c} q_1, \dots, q_l$

$$V = \{m, n, o, p, q, r, s, t\}$$

$$I = \{m\}$$

$$G = \{o, p, q, r, s\}$$

$$A = \{a_1, a_2, a_3, a_4, a_5, a_6\}$$

$$a_1 = m \xrightarrow{3} n, o$$

$$a_2 = m, o \xrightarrow{1} p$$

$$a_3 = n, o \xrightarrow{1} q$$

$$a_4 = n \xrightarrow{1} r$$

$$a_5 = p \xrightarrow{1} q, r$$

$$a_6 = p \xrightarrow{1} s$$

Illustrative Example: Relaxed Planning Graph

m^0

n^0

o^0

p^0

q^0

r^0

s^0

t^0

Illustrative Example: Relaxed Planning Graph

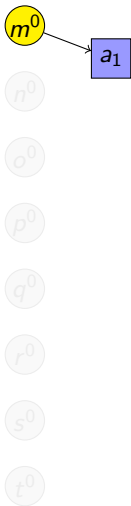

Illustrative Example: Relaxed Planning Graph

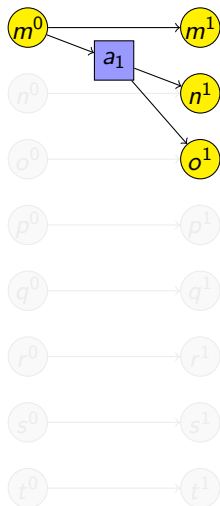

Illustrative Example: Relaxed Planning Graph

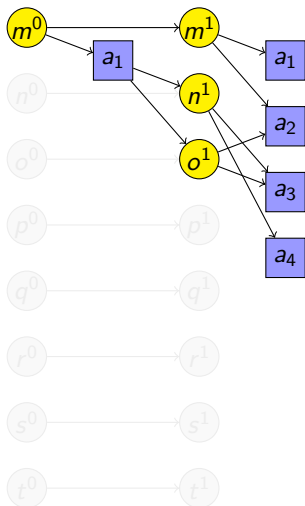

Illustrative Example: Relaxed Planning Graph

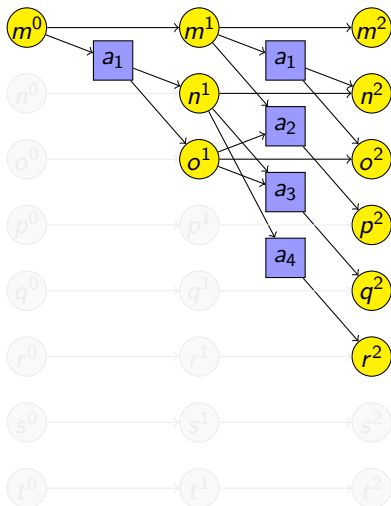

Illustrative Example: Relaxed Planning Graph

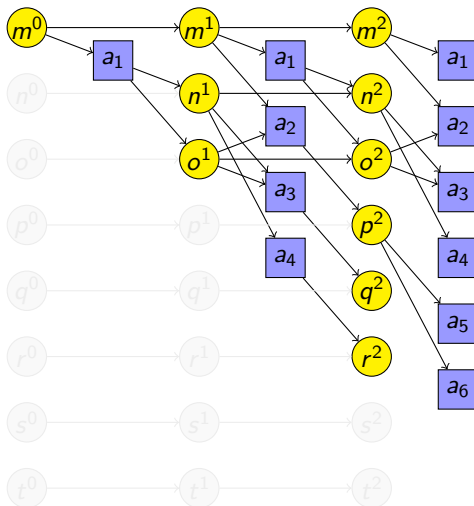

Illustrative Example: Relaxed Planning Graph

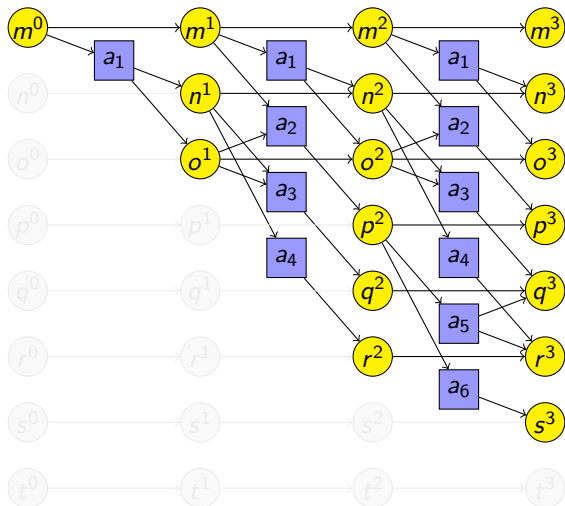

Illustrative Example: Relaxed Planning Graph

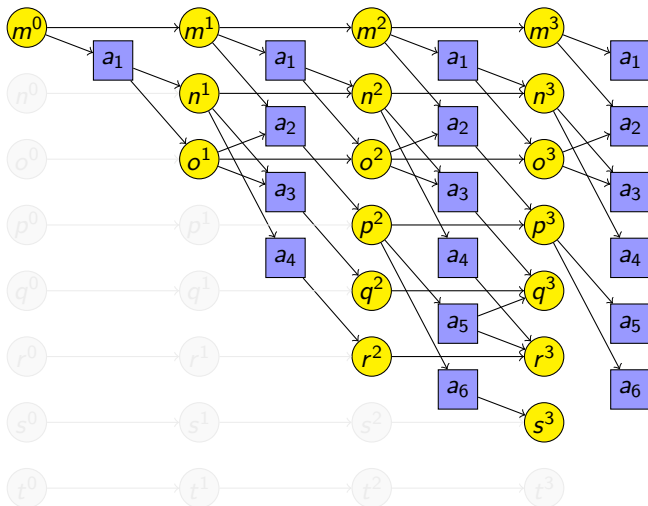

Illustrative Example: Relaxed Planning Graph

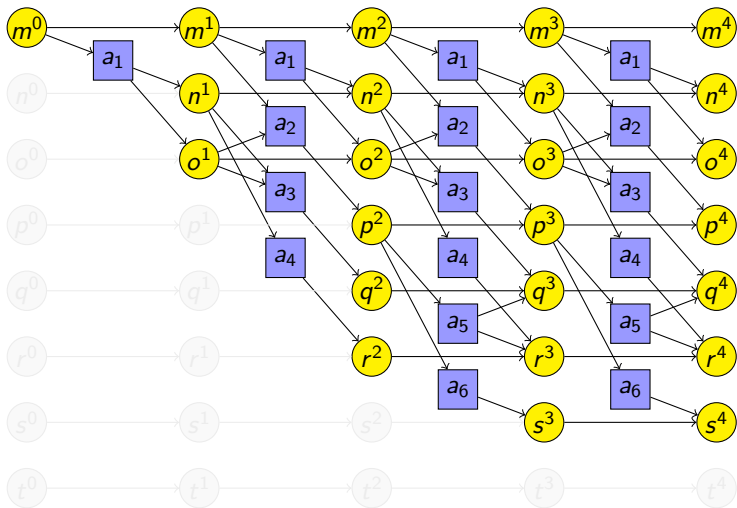

Illustrative Example: Relaxed Planning Graph

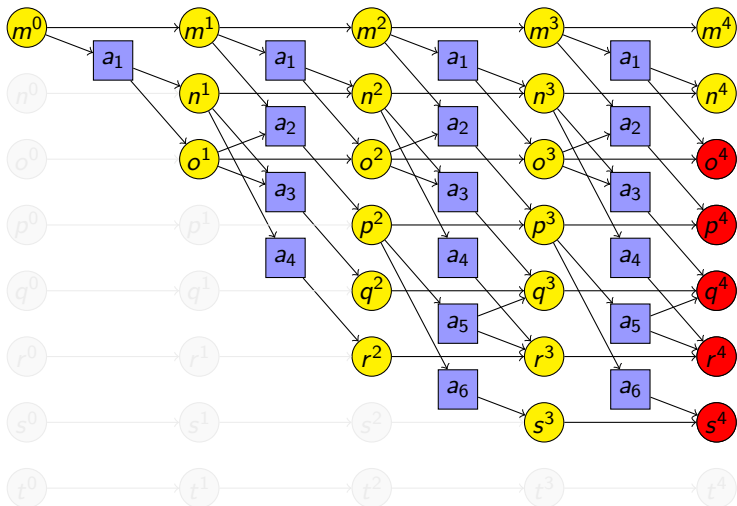

Illustrative Example: Relaxed Planning Graph

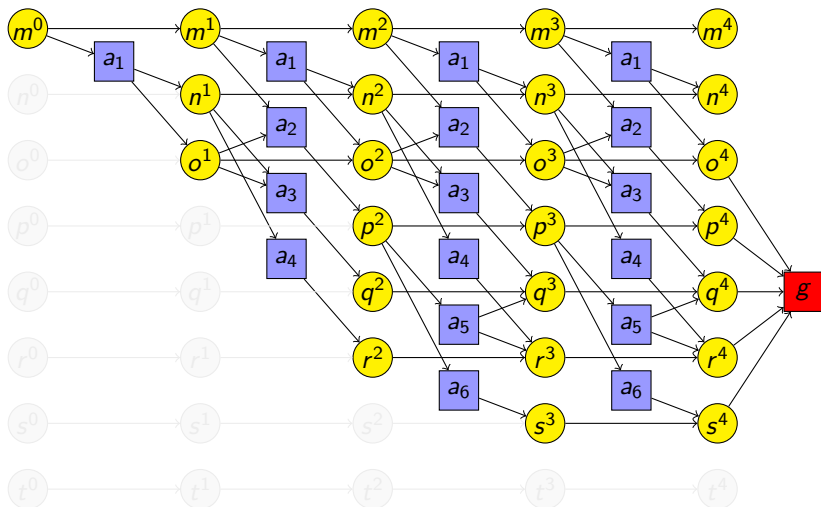

Generic Relaxed Planning Graph Heuristic

Heuristic Values from Relaxed Planning Graph

function *generic-rpg-heuristic*($\langle V, I, G, A \rangle, s$):

$\Pi^+ := \langle V, s, G, A^+ \rangle$

for $k \in \{0, 1, 2, \dots\}$:

$rpg := RPG_k(\Pi^+)$ [relaxed planning graph to layer k]

if rpg contains a goal node:

 Annotate nodes of rpg .

if termination criterion is true:

return heuristic value from annotations

else if graph has stabilized:

return ∞

↪ general template for RPG heuristics

↪ to obtain concrete heuristic: instantiate highlighted elements

Concrete Examples for Generic RPG Heuristic

Many planning heuristics fit this general template.

In this course:

- **maximum heuristic** h^{\max} (Bonet & Geffner, 1999)
- **additive heuristic** h^{add} (Bonet, Loerincs & Geffner, 1997)
- Keyder & Geffner's (2008) variant of the **FF heuristic** h^{FF} (Hoffmann & Nebel, 2001)

German: Maximum-Heuristik, additive Heuristik, FF-Heuristik

remark:

- The most efficient implementations of these heuristics do not use explicit planning graphs, but rather alternative (equivalent) definitions.

Maximum and Additive Heuristics

Maximum and Additive Heuristics

- h^{\max} and h^{add} are the simplest RPG heuristics.
- Vertex annotations are **numerical values**.
- The vertex values estimate the costs
 - to make a given variable true
 - to reach and apply a given action
 - to reach the goal

Maximum and Additive Heuristics: Filled-in Template

h^{\max} and h^{add}

computation of annotations:

- costs of variable vertices:
0 in layer 0;
otherwise **minimum** of the costs of predecessor vertices
- costs of action and goal vertices:
maximum (h^{\max}) or **sum** (h^{add}) of predecessor vertex costs;
for action vertices a^i , also add $\text{cost}(a)$

termination criterion:

- **stability**: terminate if $V^i = V^{i-1}$ and costs of all vertices in V^i equal corresponding vertex costs in V^{i-1}

heuristic value:

- value of goal vertex

Maximum and Additive Heuristics: Intuition

intuition:

- variable vertices:
 - choose **cheapest** way of reaching the variable
- action/goal vertices:
 - h^{\max} is **optimistic**: assumption:
when reaching the **most expensive** precondition variable,
we can reach the other precondition variables in parallel
(hence maximization of costs)
 - h^{add} is **pessimistic**: assumption:
all precondition variables must be reached completely
independently of each other (hence summation of costs)

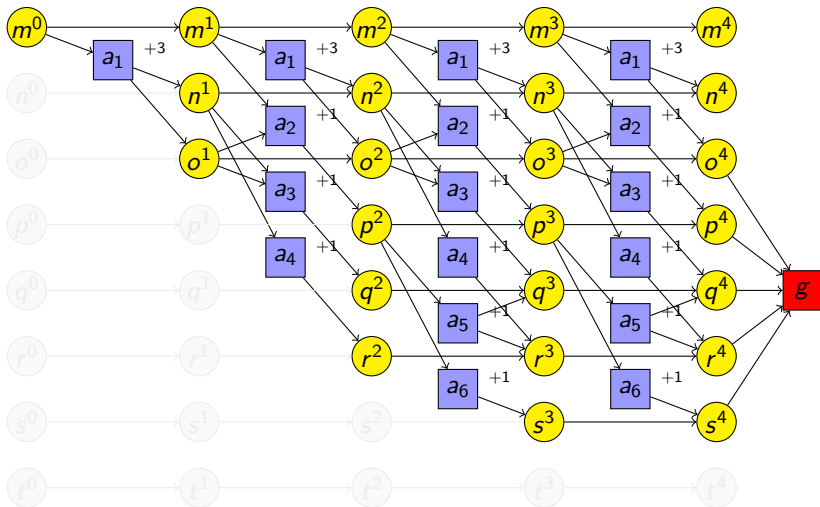
Illustrative Example: h^{\max} 

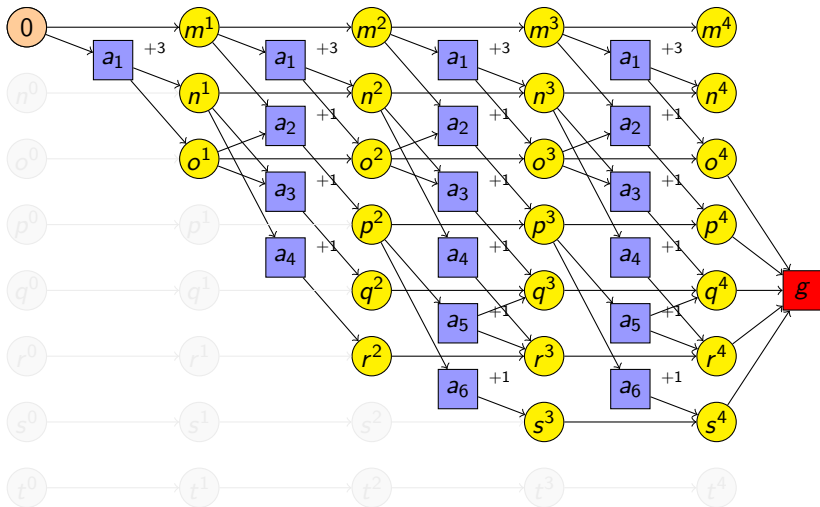
Illustrative Example: h^{\max} 

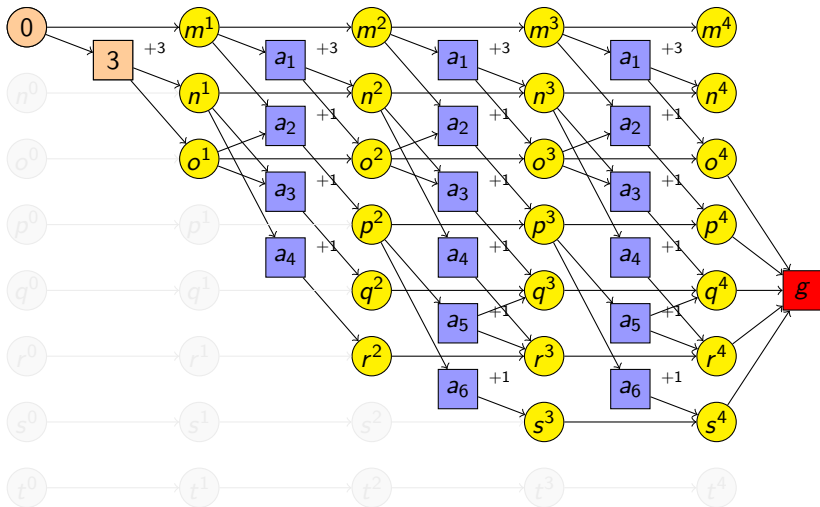
Illustrative Example: h^{\max} 

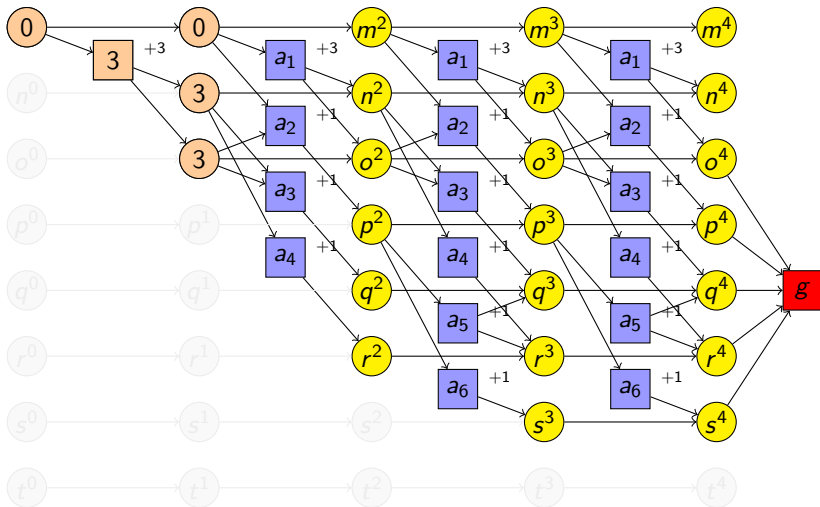
Illustrative Example: h^{\max} 

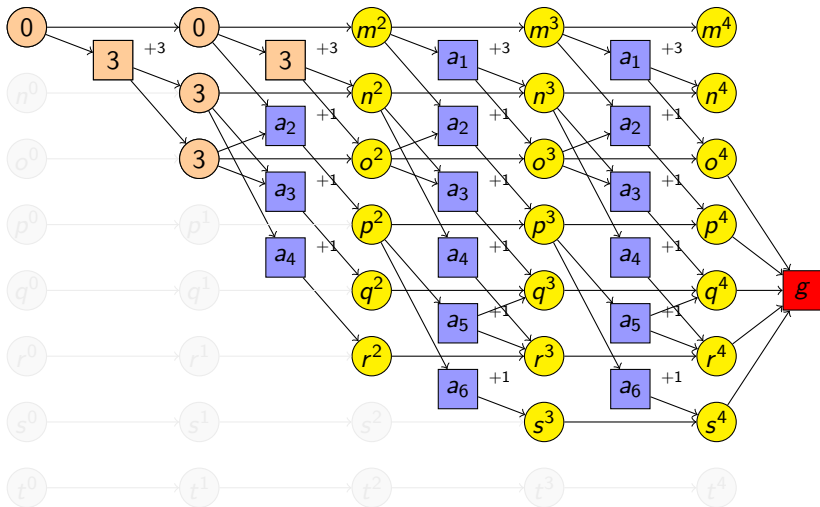
Illustrative Example: h^{\max} 

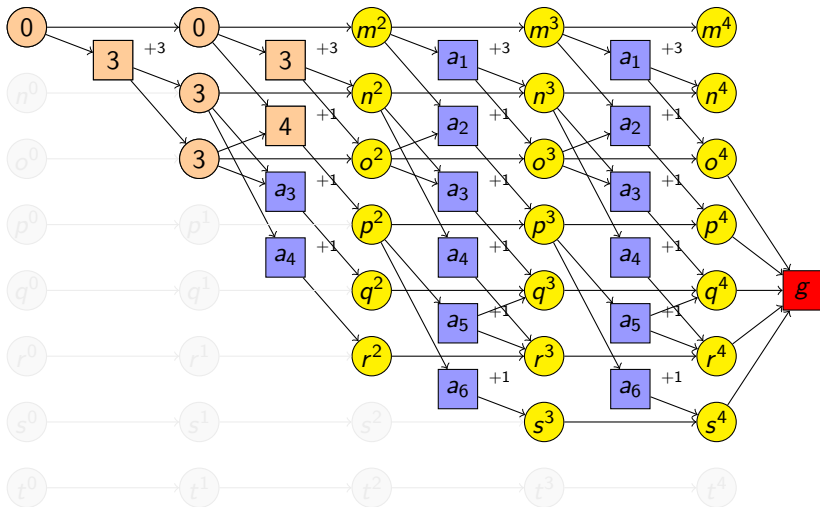
Illustrative Example: h^{\max} 

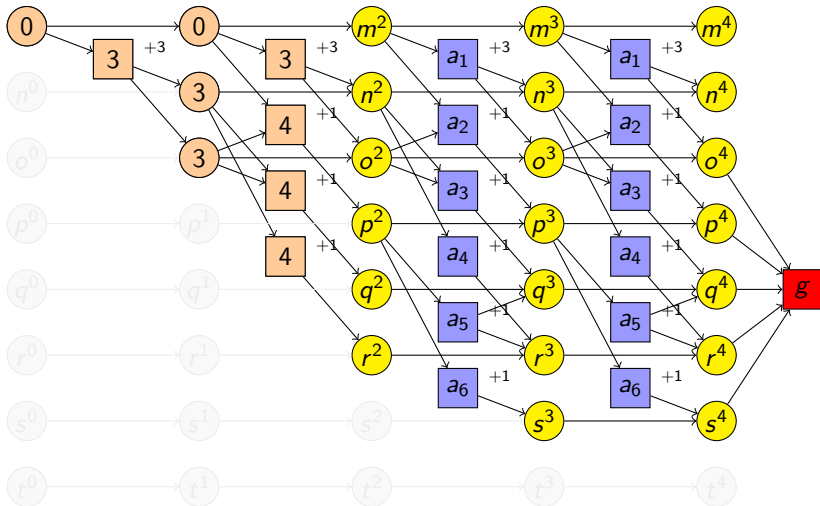
Illustrative Example: h^{\max} 

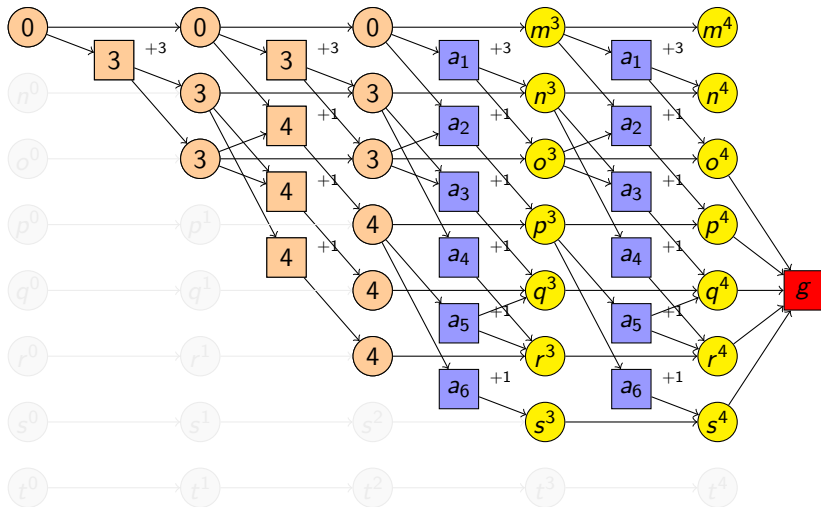
Illustrative Example: h^{\max} 

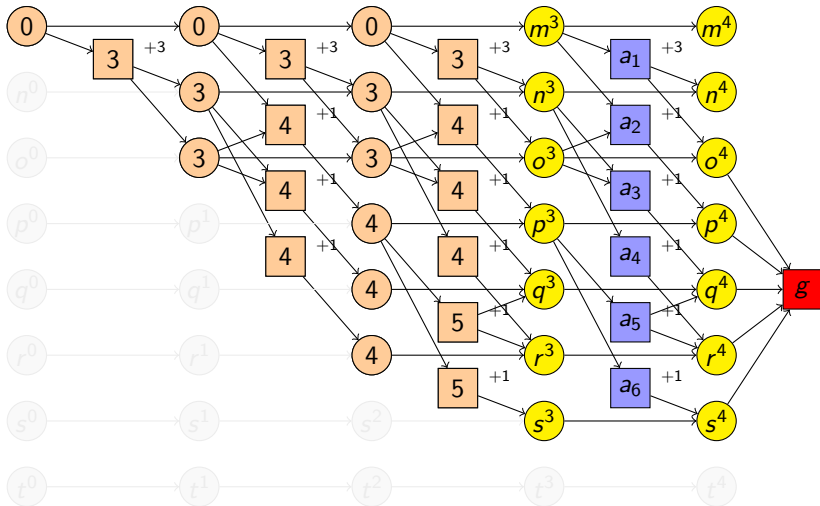
Illustrative Example: h^{\max} 

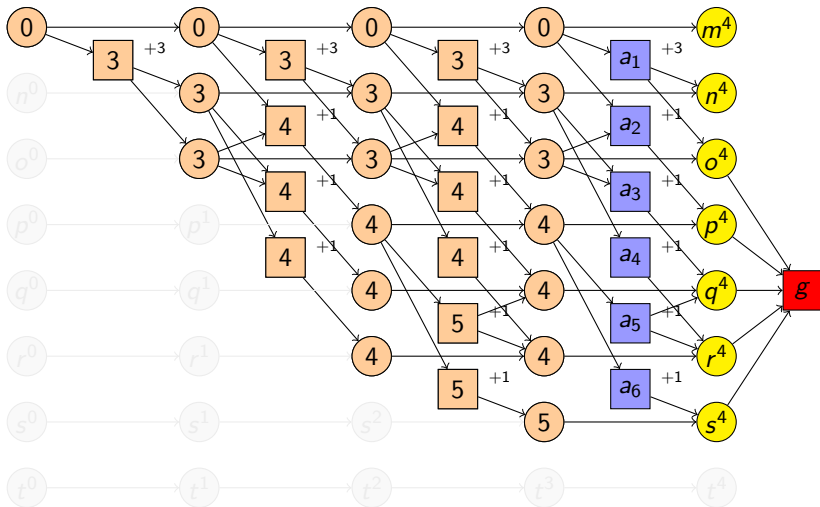
Illustrative Example: h^{\max} 

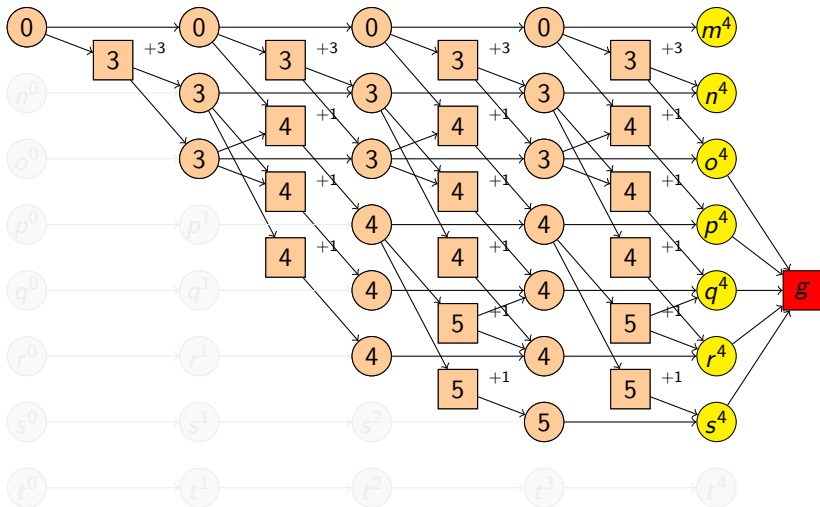
Illustrative Example: h^{\max} 

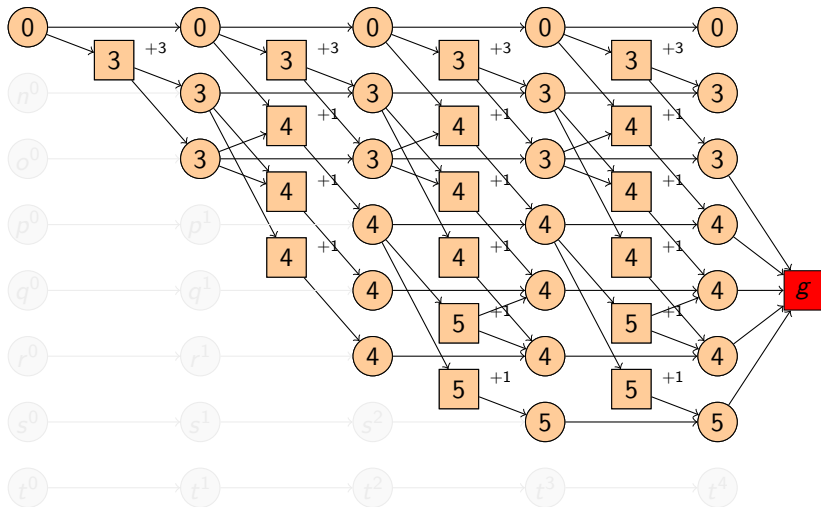
Illustrative Example: h^{\max} 

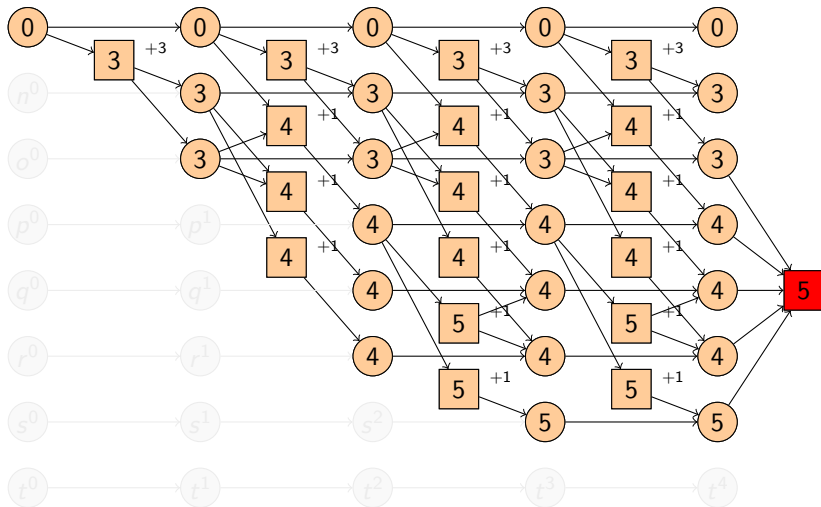
Illustrative Example: h^{\max} 

$$h^{\max}(\{m\}) = 5$$

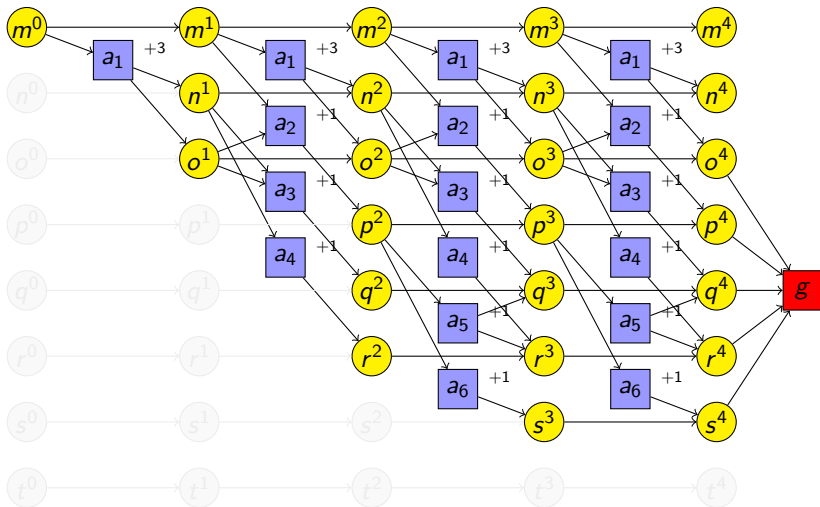
Illustrative Example: h^{add} 

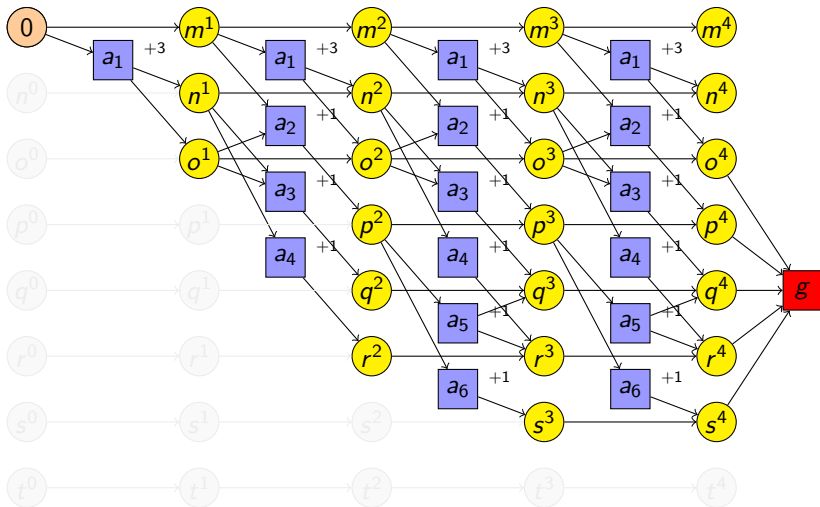
Illustrative Example: h^{add} 

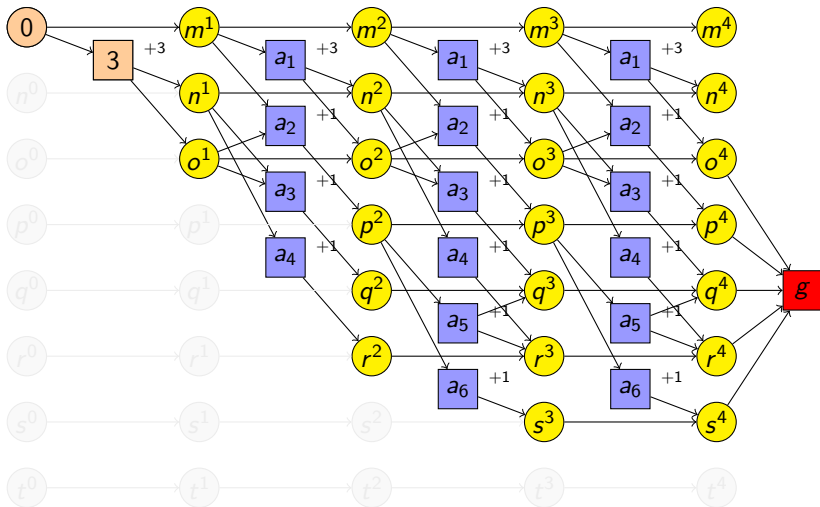
Illustrative Example: h^{add} 

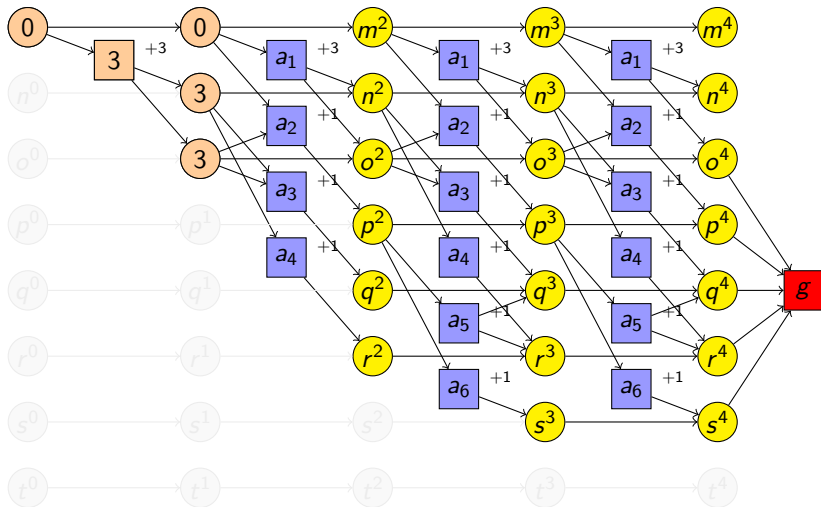
Illustrative Example: h^{add} 

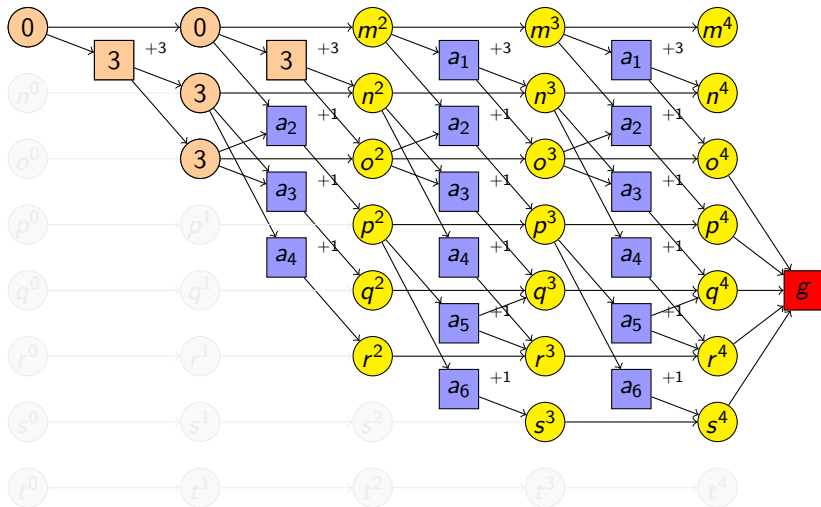
Illustrative Example: h^{add} 

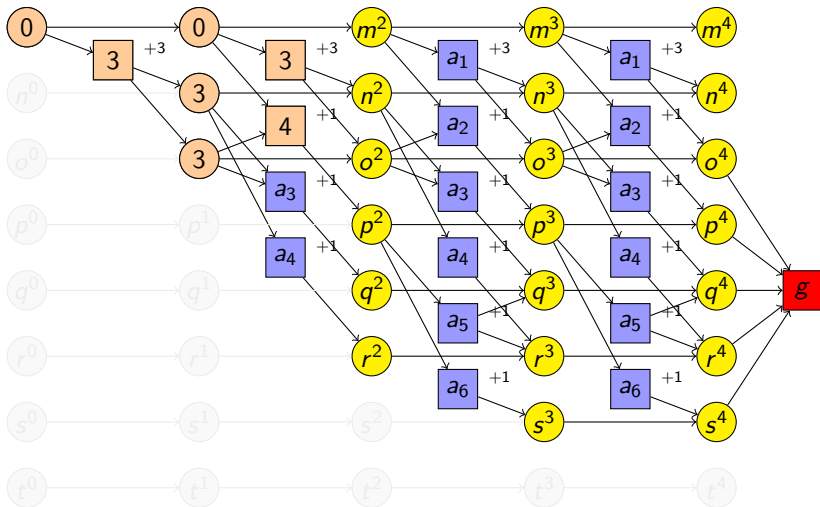
Illustrative Example: h^{add} 

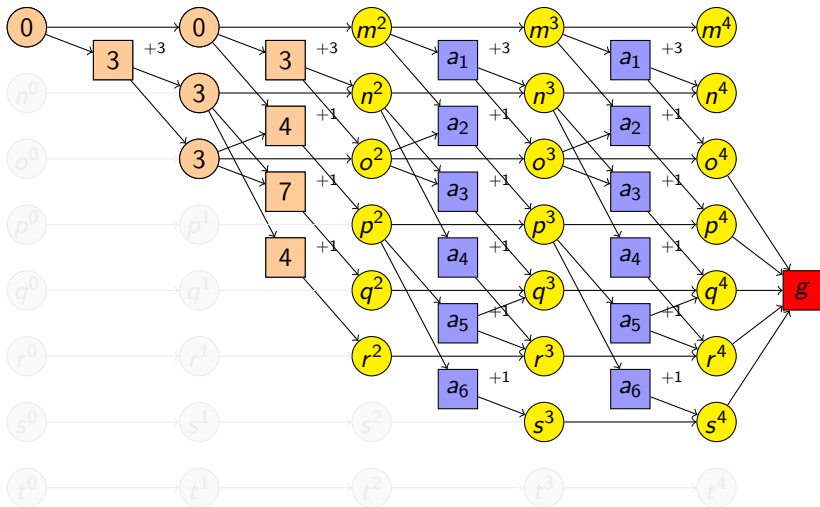
Illustrative Example: h^{add} 

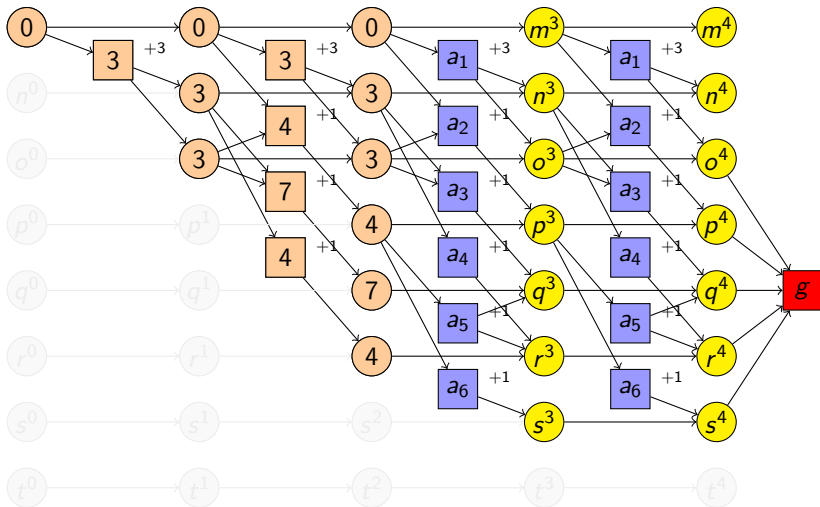
Illustrative Example: h^{add} 

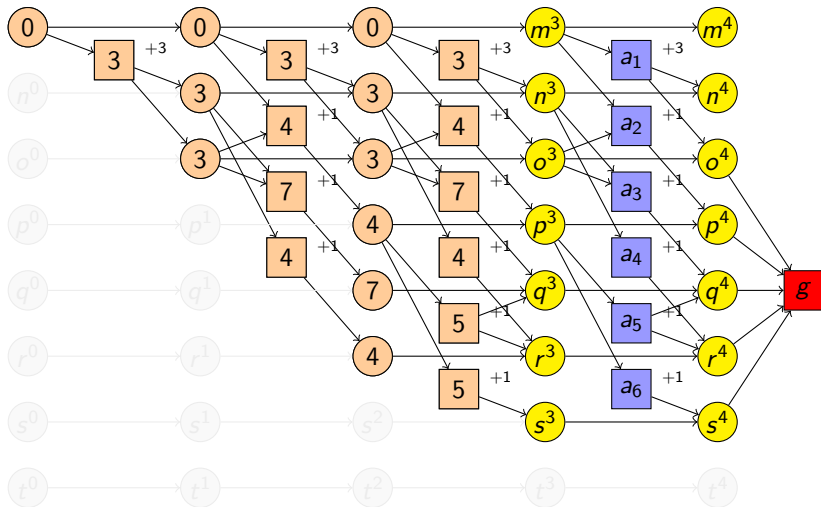
Illustrative Example: h^{add} 

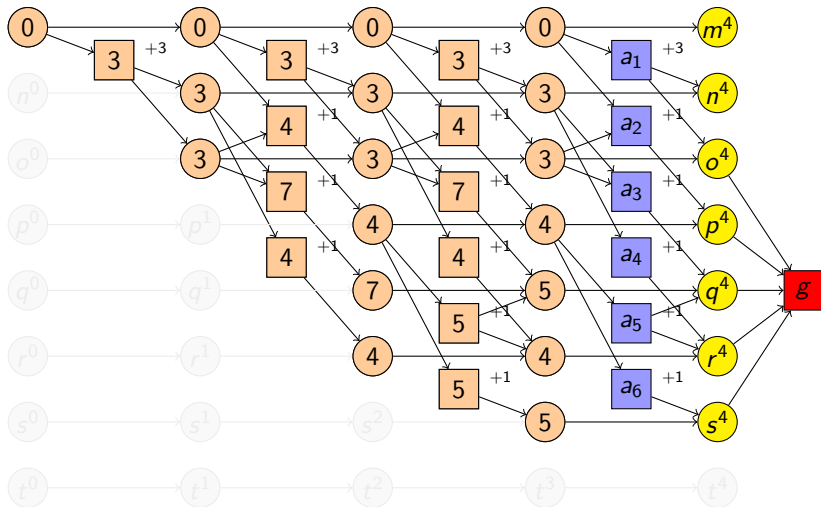
Illustrative Example: h^{add} 

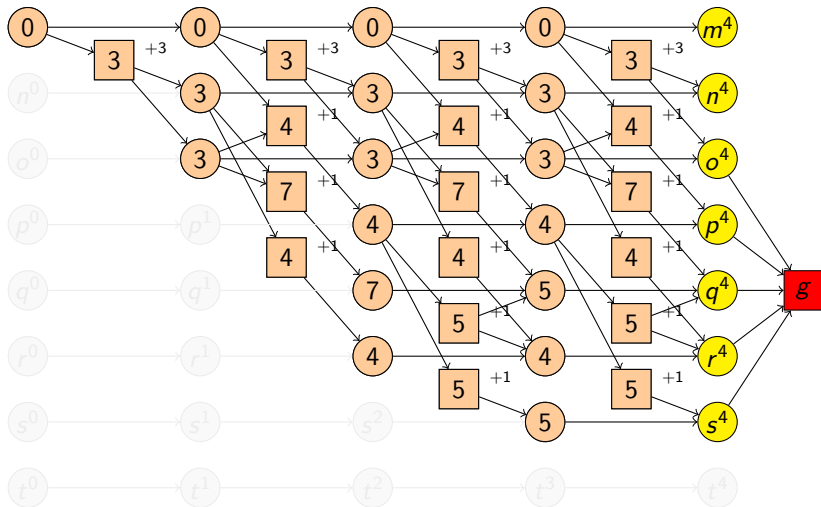
Illustrative Example: h^{add} 

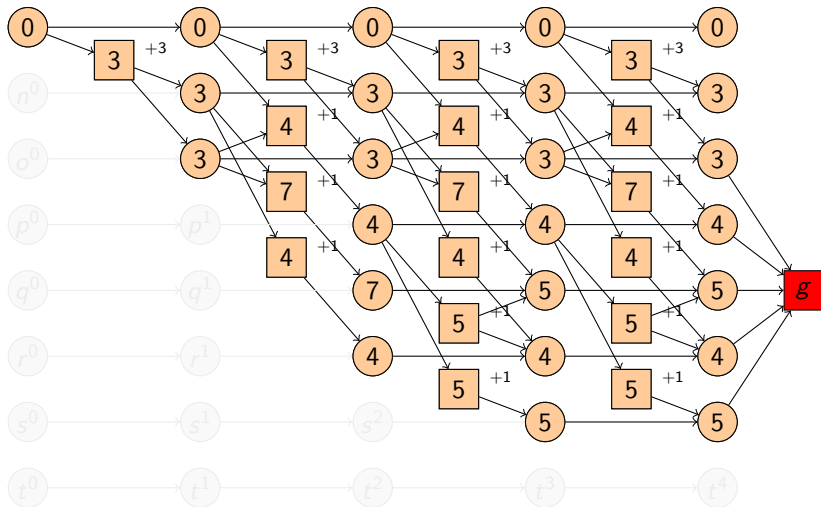
Illustrative Example: h^{add} 

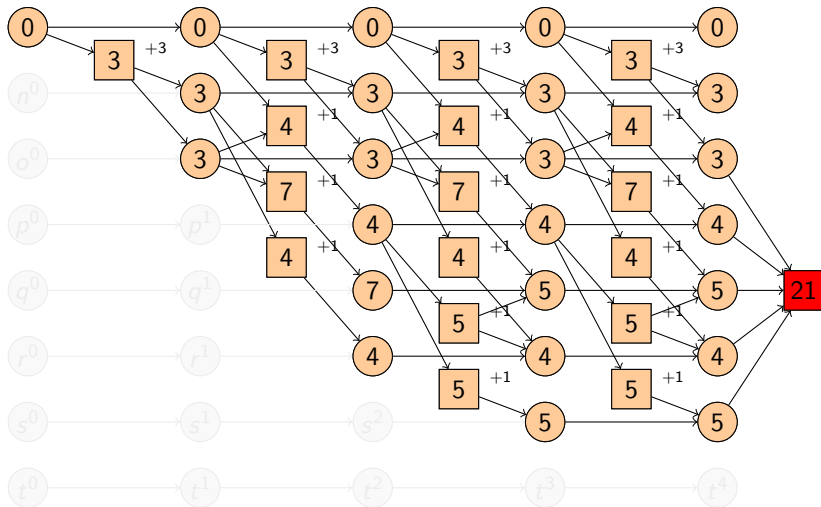
Illustrative Example: h^{add} 

$$h^{\text{add}}(\{m\}) = 21$$

h^{\max} and h^{add} : Remarks

comparison of h^{\max} and h^{add} :

- both are safe and goal-aware
 - h^{\max} is admissible and consistent; h^{add} is neither.
- ↪ h^{add} not suited for **optimal** planning

h^{\max} and h^{add} : Remarks

comparison of h^{\max} and h^{add} :

- both are safe and goal-aware
- h^{\max} is admissible and consistent; h^{add} is neither.
- ↳ h^{add} not suited for **optimal** planning
- However, h^{add} is usually **much more informative** than h^{\max} .
Greedy best-first search with h^{add} is a decent algorithm.

h^{\max} and h^{add} : Remarks

comparison of h^{\max} and h^{add} :

- both are safe and goal-aware
- h^{\max} is admissible and consistent; h^{add} is neither.
- ↳ h^{add} not suited for **optimal** planning
- However, h^{add} is usually **much more informative** than h^{\max} . Greedy best-first search with h^{add} is a decent algorithm.
- Apart from not being admissible, h^{add} often **vastly** overestimates the actual costs because **positive synergies** between subgoals are not recognized.

h^{\max} and h^{add} : Remarks

comparison of h^{\max} and h^{add} :

- both are safe and goal-aware
- h^{\max} is admissible and consistent; h^{add} is neither.

↪ h^{add} not suited for **optimal** planning

- However, h^{add} is usually **much more informative** than h^{\max} . Greedy best-first search with h^{add} is a decent algorithm.
- Apart from not being admissible, h^{add} often **vastly** overestimates the actual costs because **positive synergies** between subgoals are not recognized.

↪ FF heuristic

FF Heuristic

FF Heuristic

The FF Heuristic

identical to h^{add} , but **additional steps** at the end:

- **Mark** goal vertex.
- Apply the following **marking rules** until nothing more to do:
 - marked action or goal vertex?
↪ mark **all** predecessors
 - marked variable vertex v^i in layer $i \geq 1$?
↪ mark **one** predecessor with **minimal** h^{add} value
(tie-breaking: prefer variable vertices; otherwise arbitrary)

heuristic value:

- The actions corresponding to the marked action vertices build a relaxed plan.
- The **cost of this plan** is the heuristic value.

Illustrative Example: h^{FF}

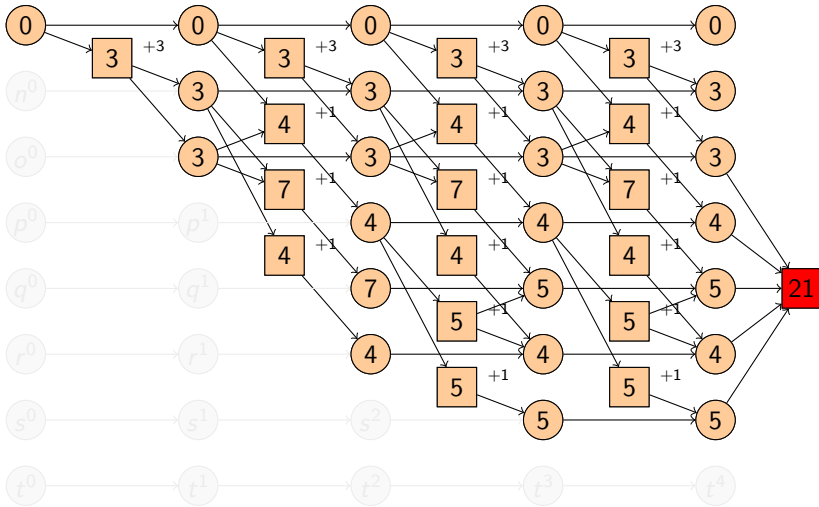

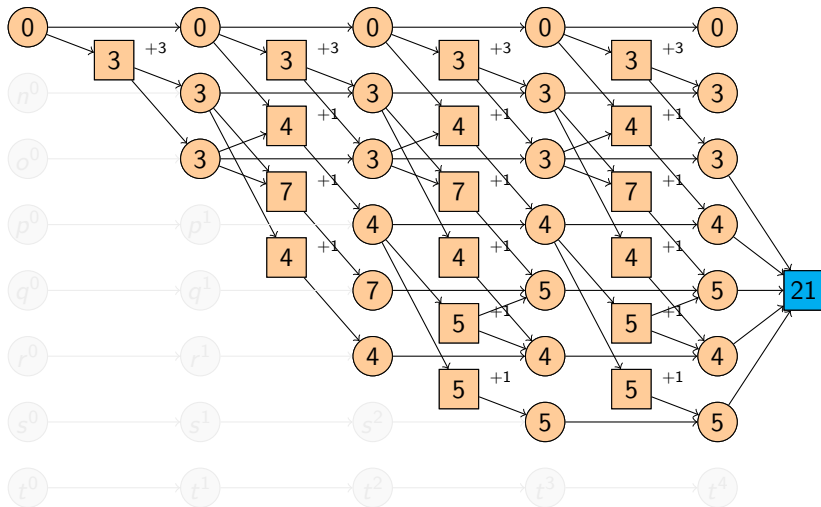
Illustrative Example: h^{FF} 

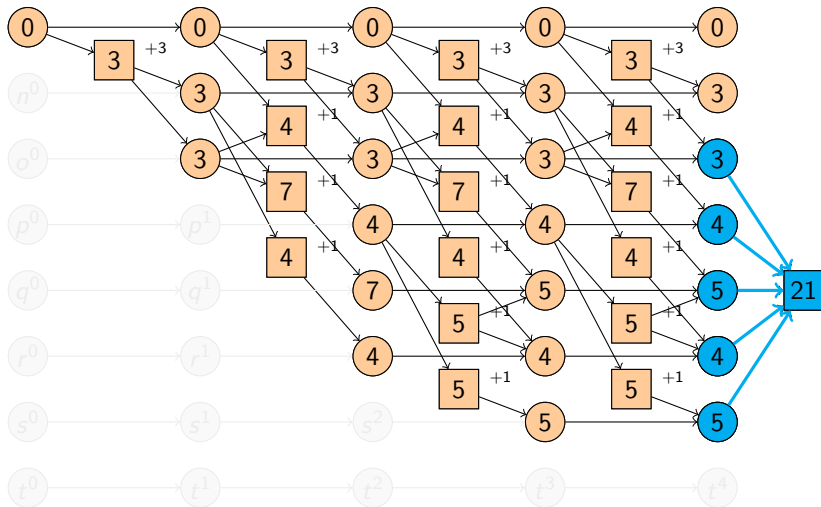
Illustrative Example: h^{FF} 

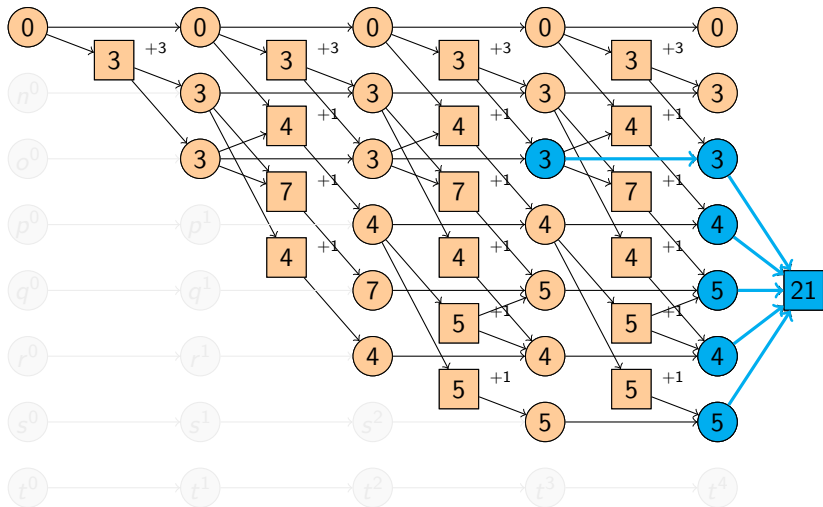
Illustrative Example: h^{FF} 

Illustrative Example: h^{FF}

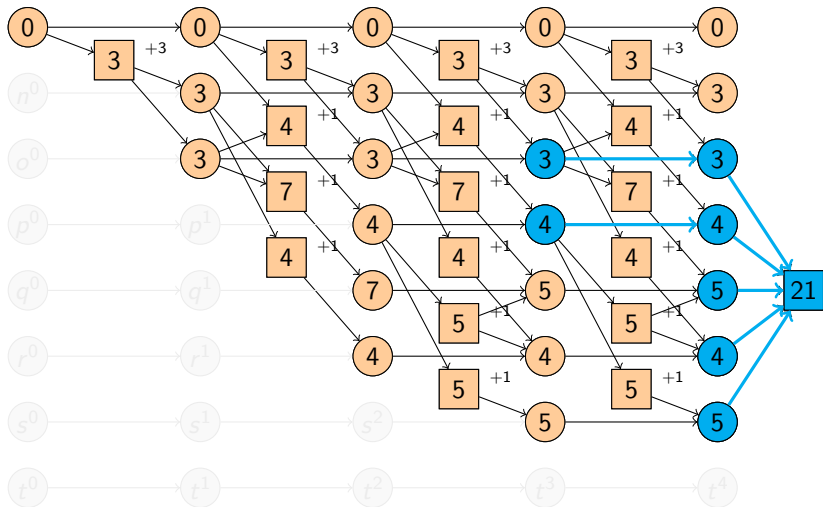

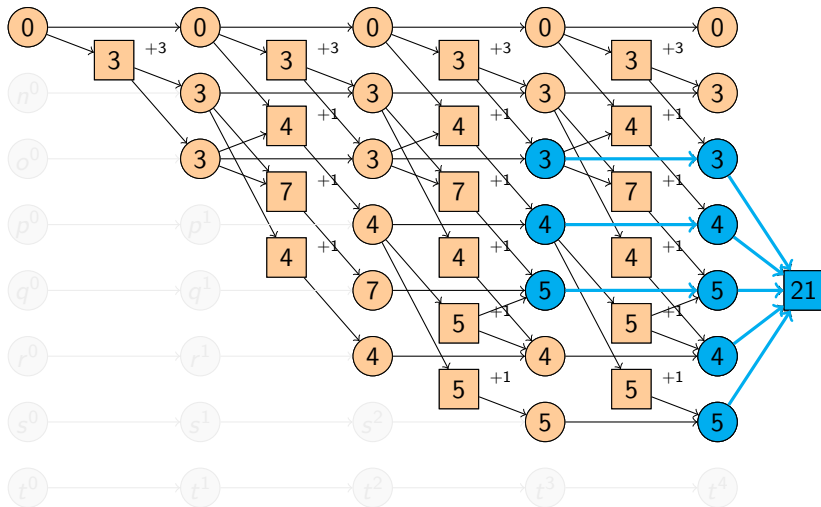
Illustrative Example: h^{FF} 

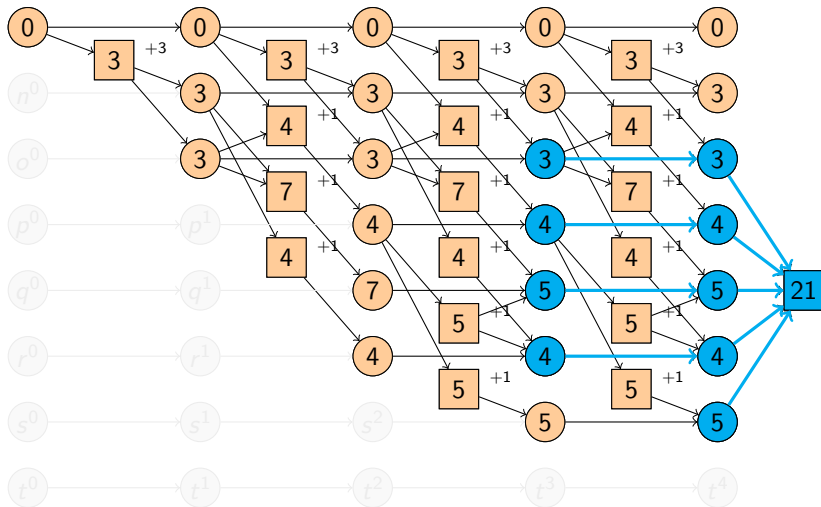
Illustrative Example: h^{FF} 

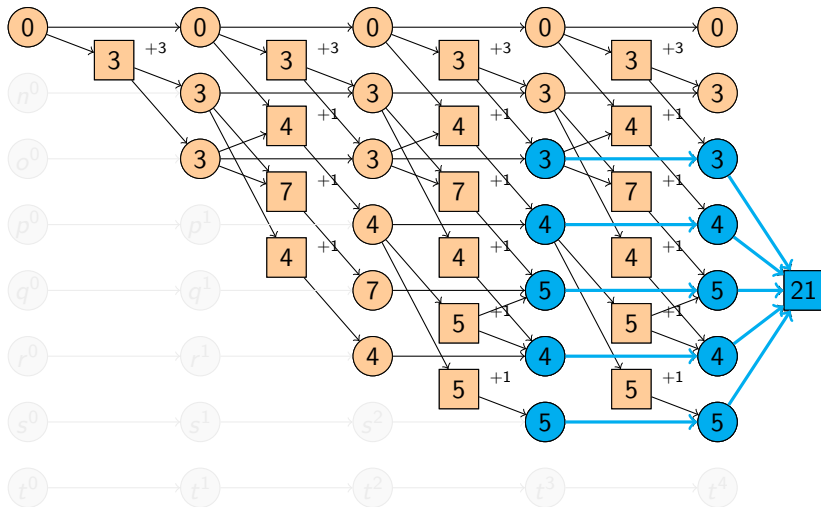
Illustrative Example: h^{FF} 

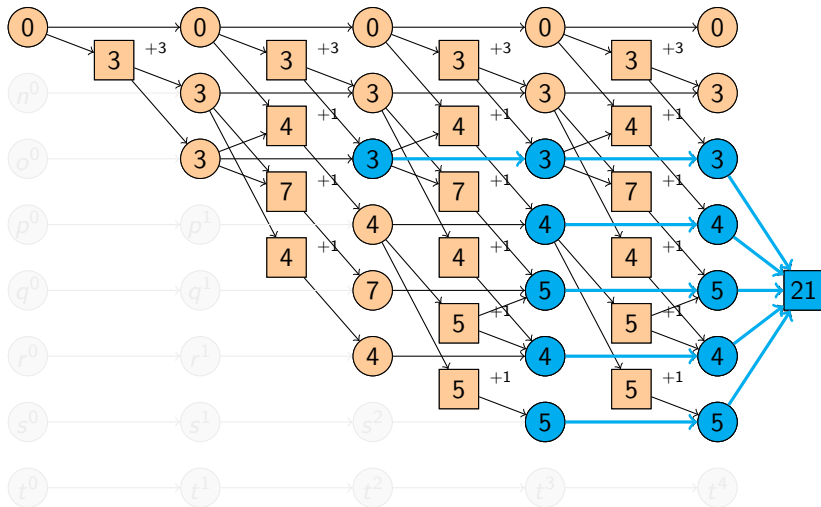
Illustrative Example: h^{FF} 

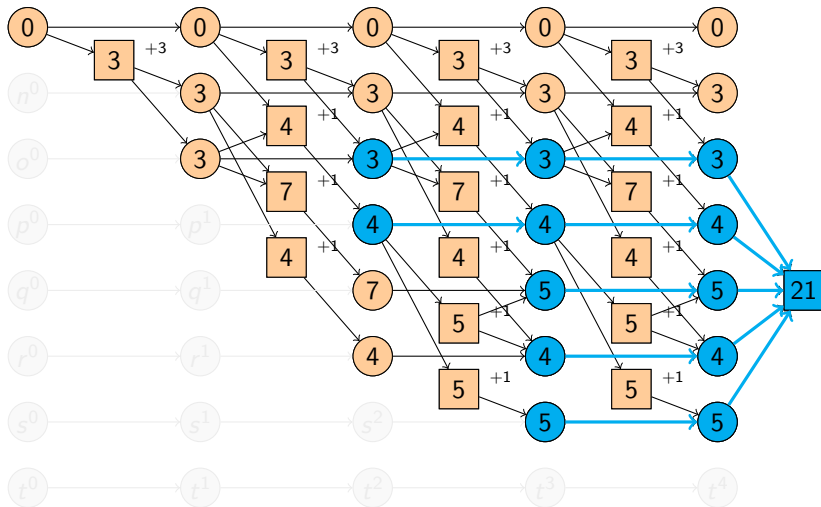
Illustrative Example: h^{FF} 

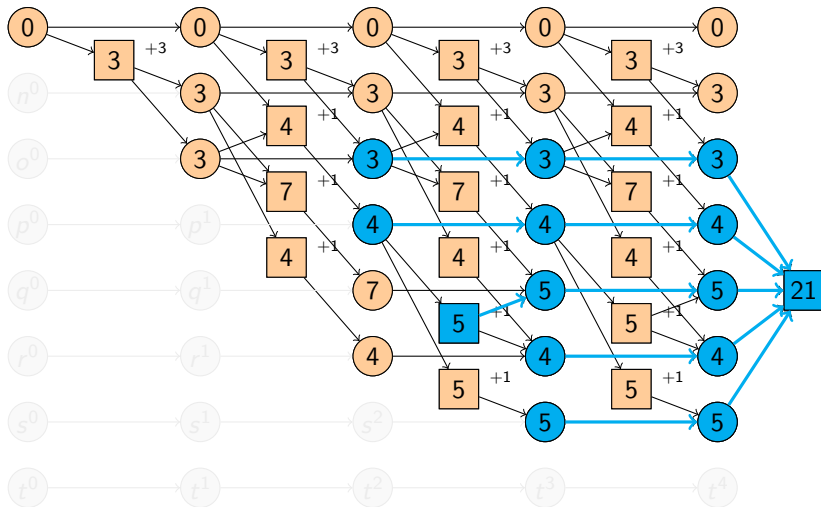
Illustrative Example: h^{FF} 

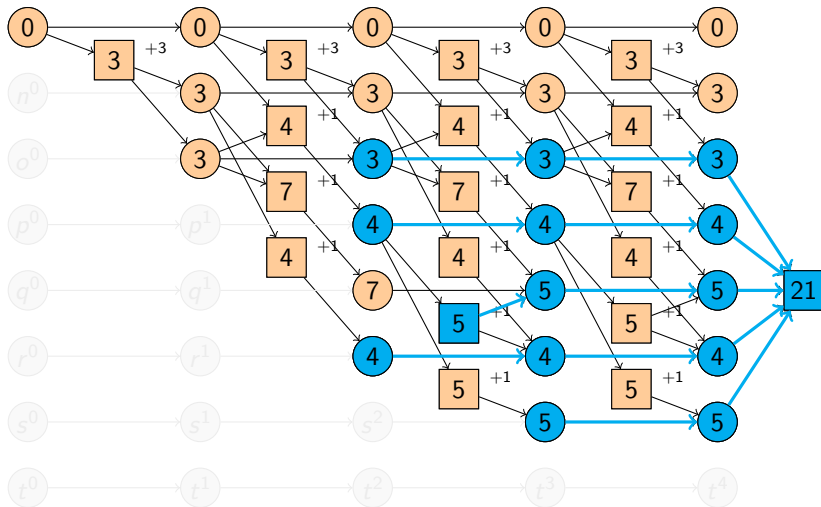
Illustrative Example: h^{FF} 

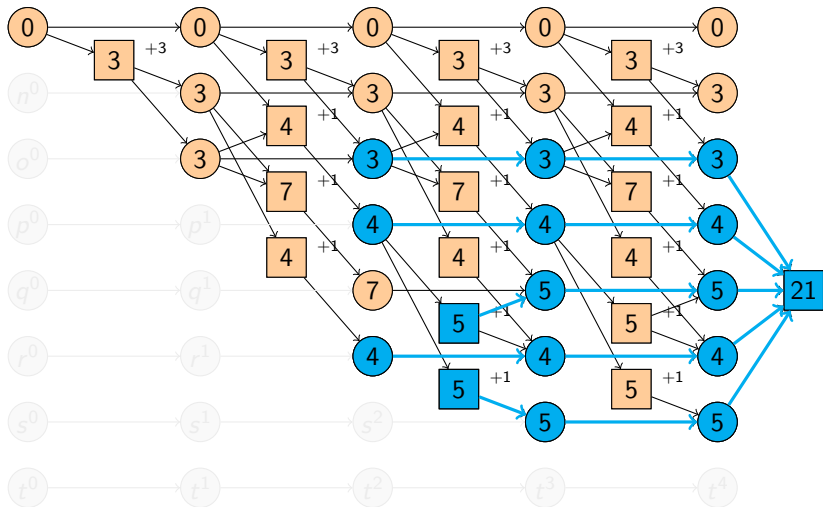
Illustrative Example: h^{FF} 

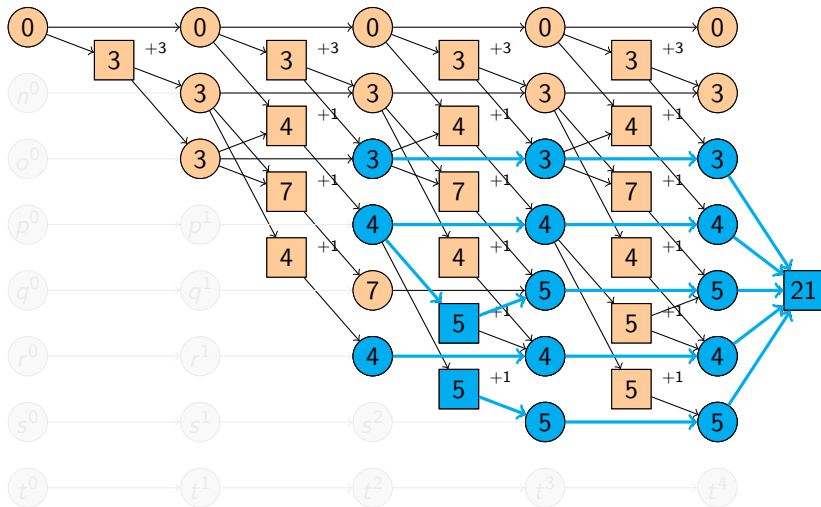
Illustrative Example: h^{FF} 

Illustrative Example: h^{FF}

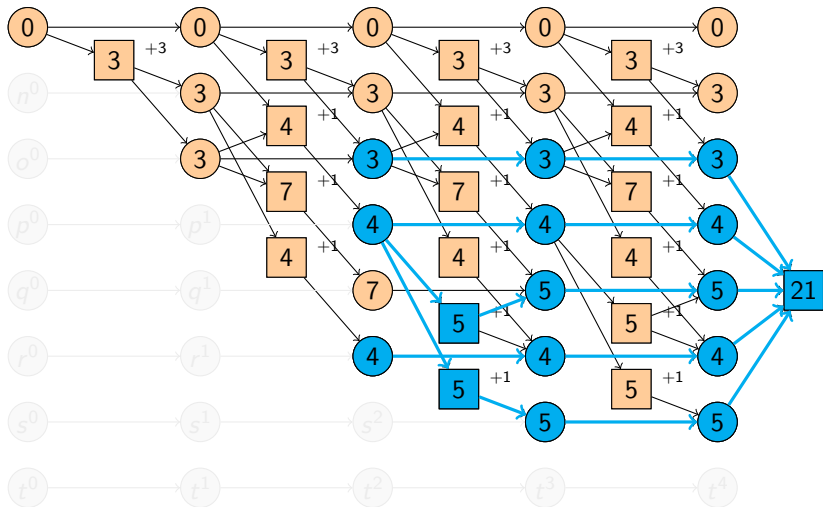

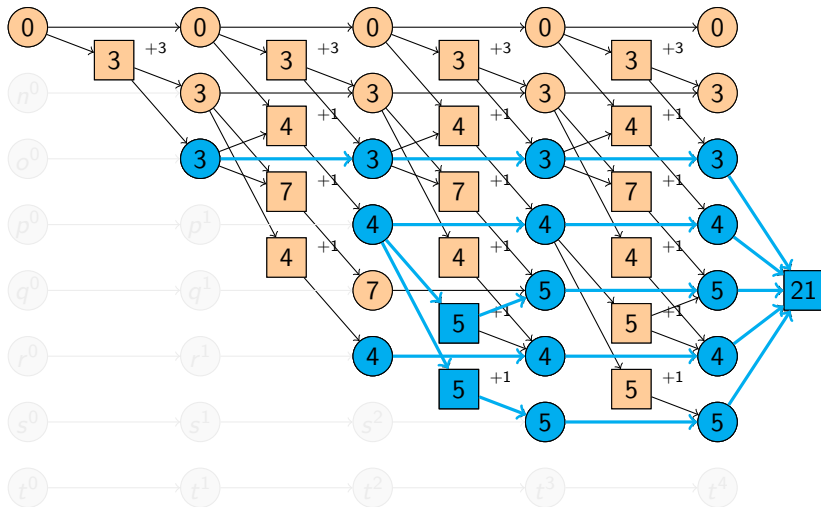
Illustrative Example: h^{FF} 

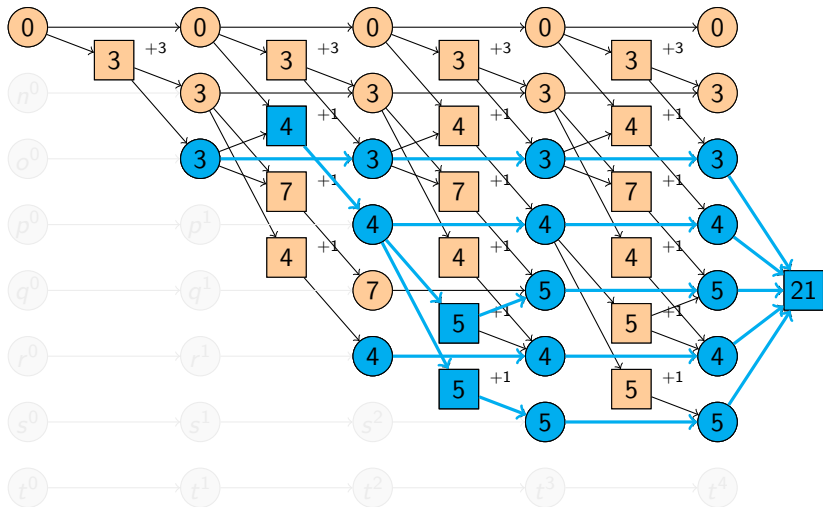
Illustrative Example: h^{FF} 

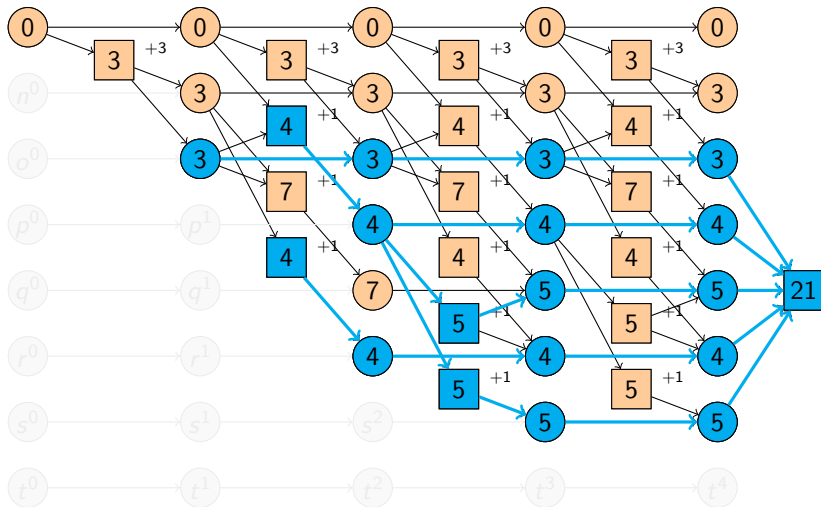
Illustrative Example: h^{FF} 

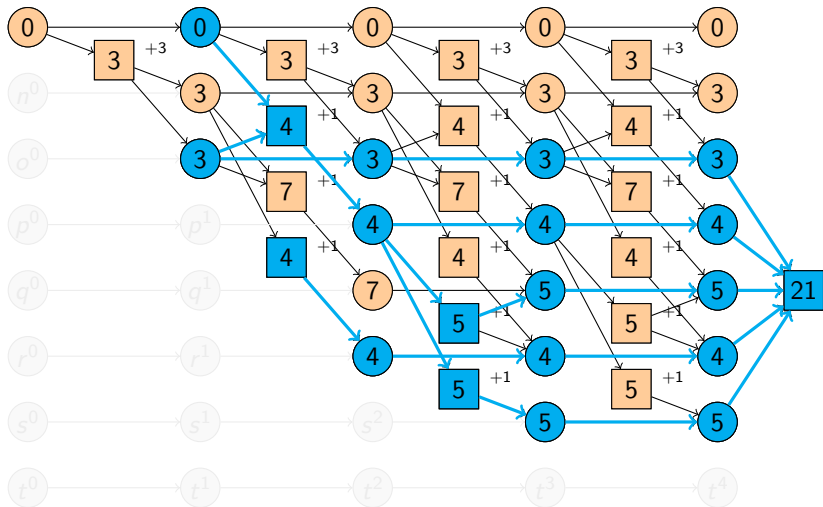
Illustrative Example: h^{FF} 

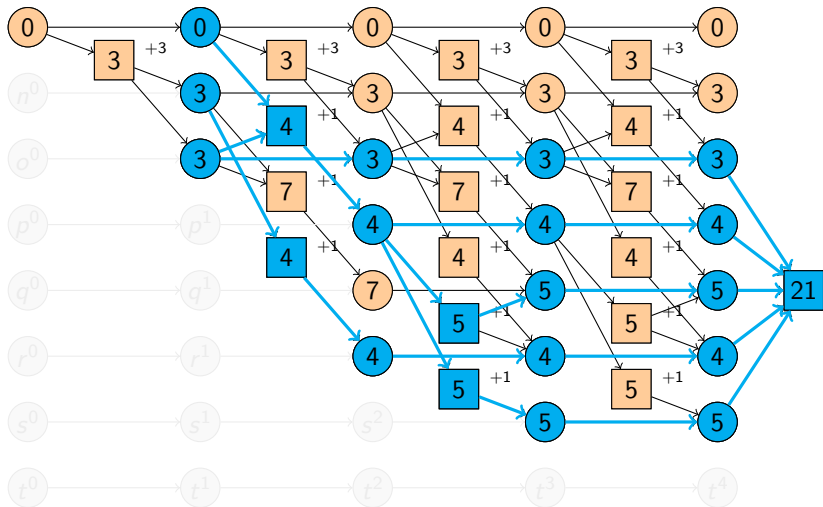
Illustrative Example: h^{FF} 

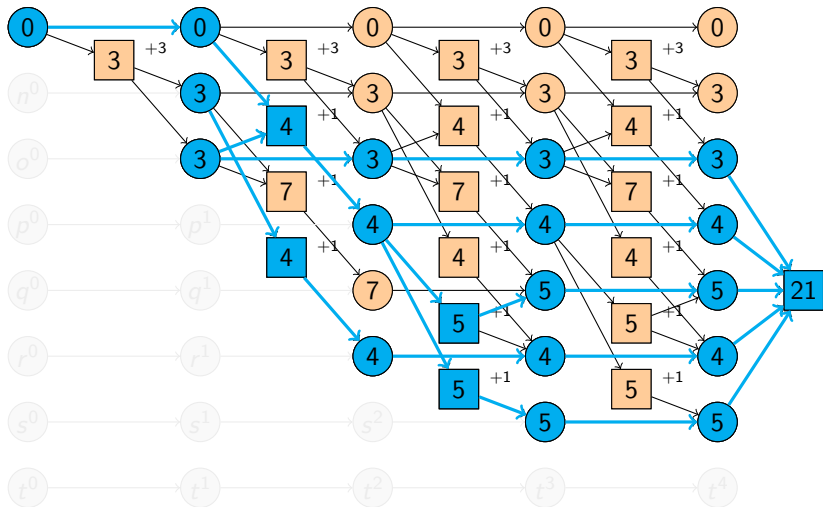
Illustrative Example: h^{FF} 

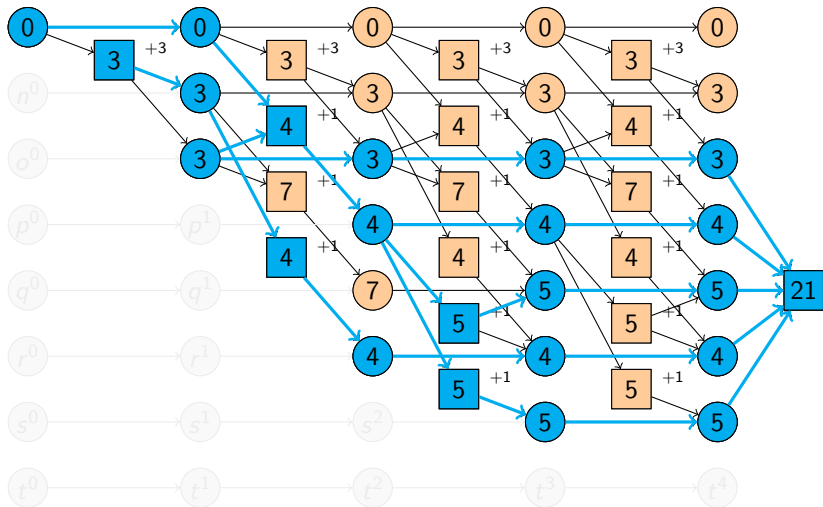
Illustrative Example: h^{FF} 

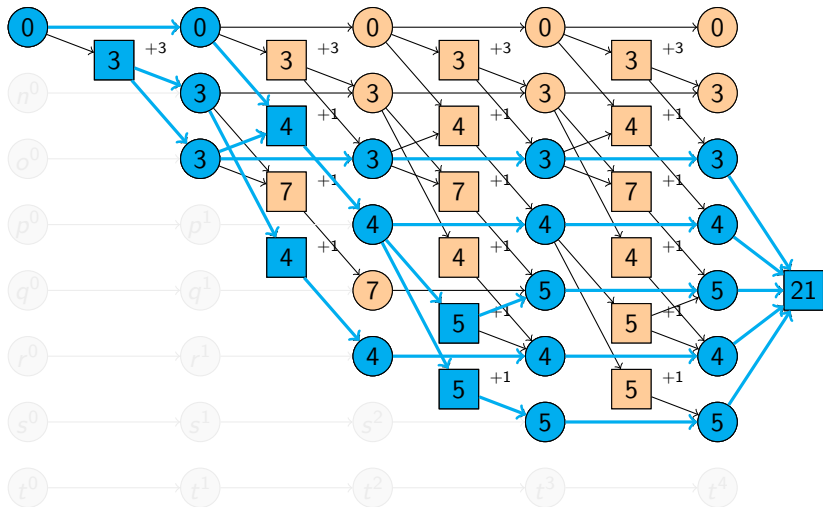
Illustrative Example: h^{FF} 

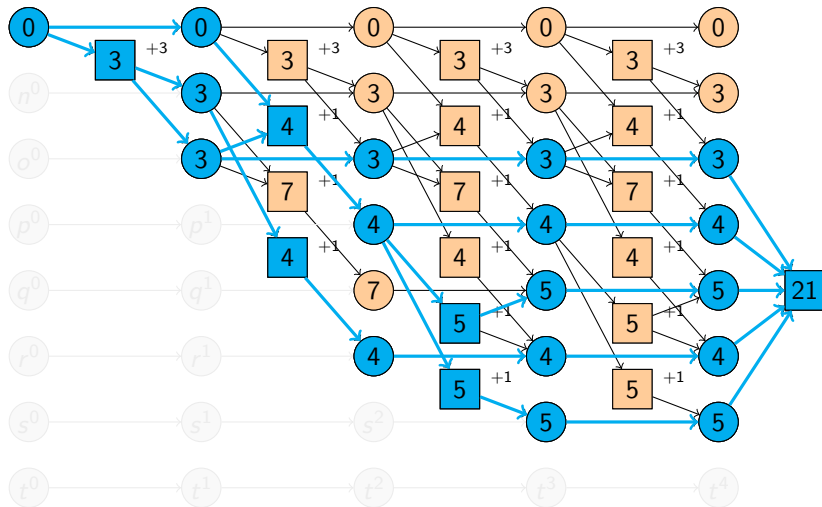
Illustrative Example: h^{FF} 

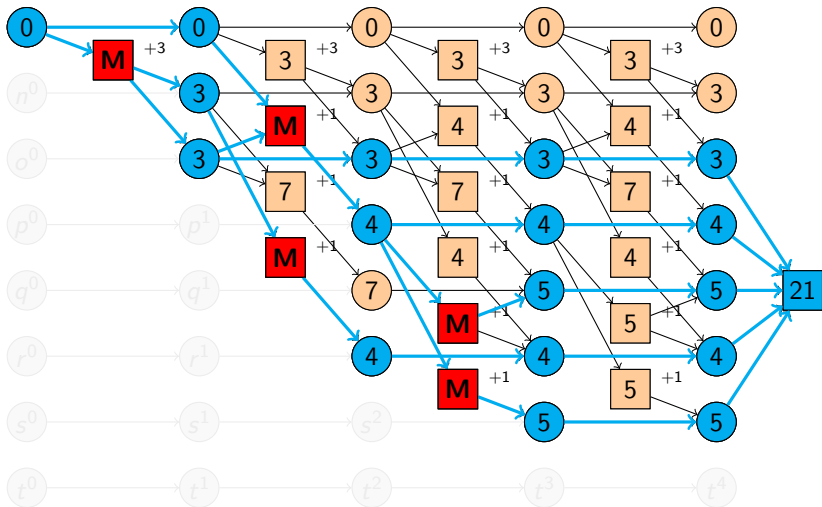
Illustrative Example: h^{FF} 

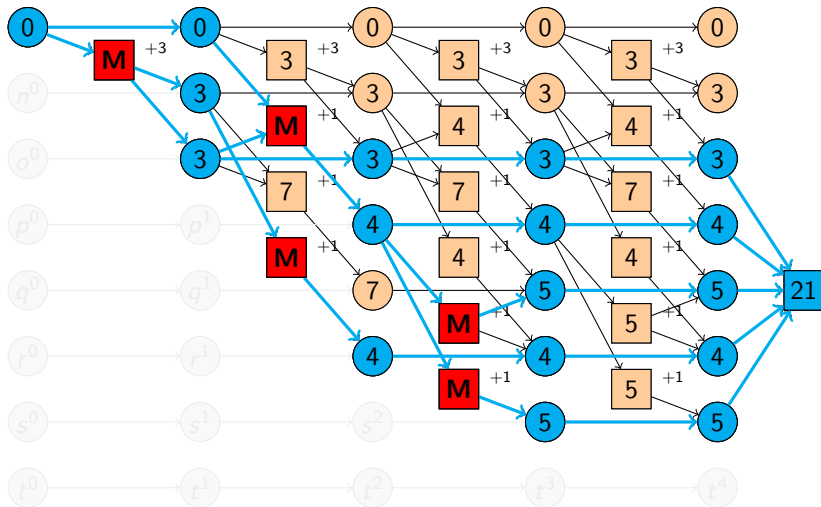
Illustrative Example: h^{FF} 

$$h^{FF}(\{m\}) = 3 + 1 + 1 + 1 + 1 = 7$$

FF Heuristic: Remarks

- Like h^{add} , h^{FF} is safe and goal-aware, but neither admissible nor consistent.
- approximation of h^+ which is **always** at least as good as h^{add}
- **usually** significantly better
- can be computed in **almost linear time** ($O(n \log n)$) in the size of the description of the planning task

FF Heuristic: Remarks

- Like h^{add} , h^{FF} is safe and goal-aware, but neither admissible nor consistent.
- approximation of h^+ which is **always** at least as good as h^{add}
- **usually** significantly better
- can be computed in **almost linear time** ($O(n \log n)$) in the size of the description of the planning task
- computation of heuristic value depends on **tie-breaking** of marking rules (h^{FF} not well-defined)
- one of the **most successful** planning heuristics

Comparison of Relaxation Heuristics

Relationships of Relaxation Heuristics

Let s be a state in the STRIPS planning task $\langle V, I, G, A \rangle$.

Then

- $h^{\max}(s) \leq h^+(s) \leq h^*(s)$
- $h^{\max}(s) \leq h^+(s) \leq h^{\text{FF}}(s) \leq h^{\text{add}}(s)$
- h^* and h^{FF} are incomparable
- h^* and h^{add} are incomparable

further remarks:

- For **non-admissible** heuristics, it is generally neither good nor bad to compute higher values than another heuristic.
- For relaxation heuristics, the objective is to approximate h^+ as closely as possible.

Summary

Summary

- Many delete relaxation heuristics can be viewed as computations on **relaxed planning graphs** (RPGs).
- examples: h^{\max} , h^{add} , h^{FF}
- h^{\max} and h^{add} propagate **numeric values** in the RPGs
 - difference: h^{\max} computes the **maximum** of predecessor costs for action and goal vertices; h^{add} computes the **sum**
- h^{FF} **marks** vertices and sums the costs of marked action vertices.
- generally: $h^{\max}(s) \leq h^+(s) \leq h^{\text{FF}}(s) \leq h^{\text{add}}(s)$