

Theory of Computer Science

B11. Turing Machines II

Gabriele Röger

University of Basel

April 13, 2022

Variants of Turing Machines

Reminder: Deterministic Turing Machine

Definition (Deterministic Turing Machine)

A (deterministic) **Turing machine (DTM)** is given by a 7-tuple $M = \langle Q, \Sigma, \Gamma, \delta, q_0, q_{\text{accept}}, q_{\text{reject}} \rangle$, where Q, Σ, Γ are finite and

- Q is the set of **states**,
- Σ is the **input alphabet**, not containing the **blank symbol** \square ,
- Γ is the **tape alphabet**, where $\square \in \Gamma$ and $\Sigma \subseteq \Gamma$,
- $\delta : (Q \setminus \{q_{\text{accept}}, q_{\text{reject}}\}) \times \Gamma \rightarrow Q \times \Gamma \times \{L, R\}$ is the **transition function**,
- $q_0 \in Q$ is the **start state**,
- $q_{\text{accept}} \in Q$ is the **accept state**,
- $q_{\text{reject}} \in Q$ is the **reject state**, where $q_{\text{accept}} \neq q_{\text{reject}}$.

Deterministic TM with a **single** tape that is infinite at **one side**.

Turing Machines with Neutral Move

- A DTM only allows head movements to the **left** or **right**.
- A DTM **with neutral move** is a variant with transition function $\delta : (Q \setminus \{q_{\text{accept}}, q_{\text{reject}}\}) \times \Gamma \rightarrow Q \times \Gamma \times \{L, R, \mathbf{N}\}$, where **N** means that the R/W-head **stays put**.

Turing Machines with Neutral Move

- A DTM only allows head movements to the **left** or **right**.
- A DTM **with neutral move** is a variant with transition function $\delta : (Q \setminus \{q_{\text{accept}}, q_{\text{reject}}\}) \times \Gamma \rightarrow Q \times \Gamma \times \{L, R, N\}$, where **N** means that the R/W-head **stays put**.

Can this variant recognize languages that standard DTMs cannot?

Turing Machines with Neutral Move are Equally Powerful

- Obviously, every DTM can be seen as a DTM with neutral move, so the variant is clearly **not less powerful**.

Turing Machines with Neutral Move are Equally Powerful

- Obviously, every DTM can be seen as a DTM with neutral move, so the variant is clearly **not less powerful**.
- Vice versa, every language recognized by a DTM M with neutral moves can be recognized by a (standard) DTM M' :

Turing Machines with Neutral Move are Equally Powerful

- Obviously, every DTM can be seen as a DTM with neutral move, so the variant is clearly **not less powerful**.
- Vice versa, every language recognized by a DTM M with neutral moves can be recognized by a (standard) DTM M' :
 - For every state q of M , M' has an additional state q' .

Turing Machines with Neutral Move are Equally Powerful

- Obviously, every DTM can be seen as a DTM with neutral move, so the variant is clearly **not less powerful**.
- Vice versa, every language recognized by a DTM M with neutral moves can be recognized by a (standard) DTM M' :
 - For every state q of M , M' has an additional state q' .
 - If M writes c , switches to state q and stays put, M' writes c , switches to state q' and moves right. Whenever M' is in one of the primed states, it does not change the tape, switches to the unprimed state q and moves left.

Turing Machines with Neutral Move are Equally Powerful

- Obviously, every DTM can be seen as a DTM with neutral move, so the variant is clearly **not less powerful**.
- Vice versa, every language recognized by a DTM M with neutral moves can be recognized by a (standard) DTM M' :
 - For every state q of M , M' has an additional state q' .
 - If M writes c , switches to state q and stays put, M' writes c , switches to state q' and moves right. Whenever M' is in one of the primed states, it does not change the tape, switches to the unprimed state q and moves left.
 - For every transition of M with neutral move, M' takes two transitions with the same result.

Turing Machines with Neutral Move are Equally Powerful

- Obviously, every DTM can be seen as a DTM with neutral move, so the variant is clearly **not less powerful**.
- Vice versa, every language recognized by a DTM M with neutral moves can be recognized by a (standard) DTM M' :
 - For every state q of M , M' has an additional state q' .
 - If M writes c , switches to state q and stays put, M' writes c , switches to state q' and moves right. Whenever M' is in one of the primed states, it does not change the tape, switches to the unprimed state q and moves left.
 - For every transition of M with neutral move, M' takes two transitions with the same result.

To show that two models are equivalent,
we can show that we can simulate one by the other.

Questions

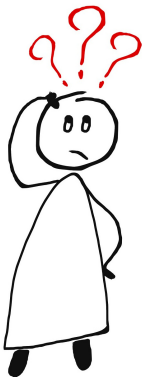

Questions?

Multitape Turing Machines

Multitape Turing Machines

A multitape TM is like a DTM (with neutral movement) but with several tapes.

- every tape has its own read-write head,
- the input appears on tape 1,
- all other tapes are initially filled with blank symbols,
- the transition function considers all k tapes simultaneously

$$\delta : (Q \setminus \{q_{\text{accept}}, q_{\text{reject}}\}) \times \Gamma^k \rightarrow Q \times \Gamma^k \times \{L, R, N\}^k$$

Multitape Turing Machines: Conceptually

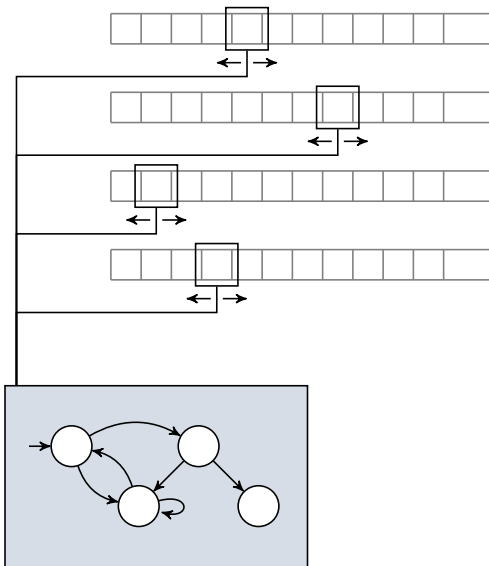

Multitape Turing Machine: Transitions

$$\delta(q, a_1, \dots, a_k) = (q', a'_1, \dots, a'_k, D_1, \dots, D_k)$$

- If the TM is in state q ,
- and on each tape i the head reads symbol a_i , then
- the TM switches to state q' ,
- replaces on each tape i the symbol a_i with a'_i , and
- moves the head on each tape i in direction D_i
($D_i \in \{L, R, N\}$)

Multitape TMs No More Powerful Than Single-Tape TMs

Theorem

Every multitape TM has an equivalent single-tape TM.

Proof.

Let M be a TM with k tapes. We construct a single-tape DTM S that recognizes the same language.

S stores the information of the multiple tapes on its tape, separating the contents of different tapes with a new symbol $\#$.

To keep track of the positions of the heads of M , TM S has for each tape symbol x of M a new tape symbol \dot{x} to mark the corresponding positions. ...

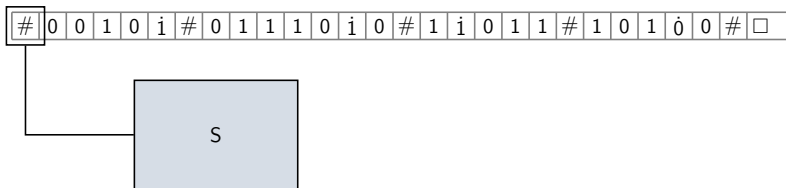
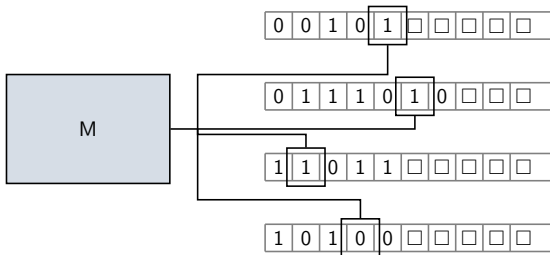

Multitape TMs No More Powerful Than Single-Tape TMs

Theorem

Every multitape TM has an equivalent single-tape TM.

Proof (continued).

On input $w = w_1 \dots w_n$

- 1 Initialize the tape of S to $\#w_1w_2\dots w_n\#\square\#\square\#\dots\#$
- 2 To simulate a transition of M , TM S scans from the leftmost $\#$ to the $k + 1$ st $\#$ to determine what symbols are under the virtual heads. In a second pass, S updates the tape according to the transition of M .
- 3 If it moves a virtual head on the $\#$ marking the right end of its tape, it frees this position by shifting the tape content from this position on one position to the right and adds a blank into the “new” position.



Details?

Consider the situation where S has done its first pass (back at the left-most position) and has determined that M would take transition

$$\delta(q, x_1, \dots, x_k) = (q, y_1, \dots, y_k, D_1, \dots, D_k).$$

How can you “implement” the second pass of S that updates the tape accordingly? You may assume that it will never move a virtual head from the already represented part of its tape.

First pass and shifting the tape content \rightsquigarrow exercises



Multitape TMs Equally Powerful as Single-Tape TMs

Theorem

A language is Turing-recognizable iff some multitape Turing machine recognizes it.

Proof.

“ \Rightarrow ”: A DTM is a special case of a multitape TM.

“ \Leftarrow ”: Previous theorem



Questions

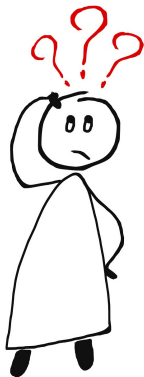

Questions?

Nondeterministic Turing Machines

Nondeterministic Turing Machines

A nondeterministic Turing machine (NTM) relates to a DTM as a NFA relates to a DFA.

- The transition function can specify several possibilities:
$$\delta : (Q \setminus \{q_{\text{accept}}, q_{\text{reject}}\}) \times \Gamma \rightarrow \mathcal{P}(Q \times \Gamma \times \{L, R, N\})$$
- For a given input, we can consider the computation tree whose branches correspond to following different possibilities.
- If some branch leads to the accept state, the NTM accepts the input word.

Nondeterministic TMs no More Powerful than DTMs

Theorem

Every nondeterministic Turing machine has an equivalent deterministic Turing machine.

Nondeterministic TMs no More Powerful than DTMs

Proof.

Let N be a NTM. We describe a deterministic 3-tape TM D that searches the computation tree of N on input w for an accepting configuration with a breadth-first search. The theorem follows from the equivalence of multitape TMs and DTMs.

The first tape always contains w , the second tape corresponds to the content of N 's tape on some branch of the computation tree and the third tape tracks the position in N 's computation tree. . . .

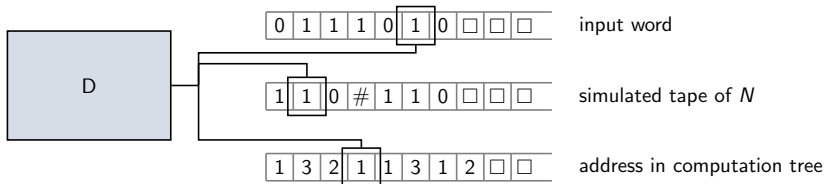

Nondeterministic TMs no More Powerful than DTMs

What is the “address in the computation tree”?

- Let b be the maximal number of children of a node in the CT (= size of largest set of possibilities in the transition function)
- The address is a string over $\{1, 2, \dots, b\}$.
- For example, address 312 refers to the node in the CT reached by starting from the root node (= initial configuration)
 - going to the third child node, then
 - going to the first child of the resulting node, and then
 - going to the second child of this child node.
- If a node does not have that many children, the address is *invalid*.

Nondeterministic TMs no More Powerful than DTMs

Proof (continued).

D works on input w as follows:

- 1 Initially, tape 1 contains w , tape 2 and 3 contain only blanks.
- 2 Copy tape 1 to tape 2.
- 3 Simulate N on input w following one branch of the computation tree. Before each transition of N , determine which choice to make from the next symbol on tape 3. If there is no number left on tape 3, if the choice is invalid or a rejecting configuration is encountered, go to step 4. If an accepting configuration is encountered, accept.
- 4 Replace the string on tape 3 with the next string (first short strings then longer ones, strings of same length in lexicographic order) and go to step 2.



Nondeterministic TMs no More Powerful than DTMs

Wouldn't it be easier to do a depth-first search for an accepting configuration in the computation tree?
Why don't we do this and e.g. first entirely explore the first branch of the tree?



NTMs and DTMs are Equally Powerful

Theorem

A language is Turing-recognizable iff some nondeterministic Turing machine recognizes it.

Proof.

“ \Rightarrow ”: Any DTM can be cast as a NTM.

“ \Leftarrow ”: Previous theorem



Questions

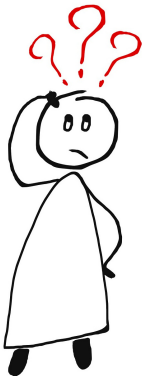

Questions?

Summary

Summary

We have seen several variants of Turing machines:

- Deterministic TM with head movements left or right
- Deterministic TM with head movements left, right or **neutral**
- **Multitape** Turing machines
- **Nondeterministic** Turing machines

All variants recognize the same languages.